

Panasonic[®]



Reference Manual

Personal Computer

Model No. **CF-19 Series**



We recommend that this Reference Manual be printed.

Key	Function	Popup menu icon
<u>Fn</u>+<u>F4</u> ^{*1}	Speaker on/off NOTE <ul style="list-style-type: none"> Beeps do not sound if you turn off the speaker sound^{*2}. 	  OFF (MUTE) ON
<u>Fn</u>+<u>F5</u> ^{*1} <u>Fn</u>+<u>F6</u> ^{*1}	Volume (<u>Fn</u>+<u>F5</u> = down / <u>Fn</u>+<u>F6</u> = up)	
<u>Fn</u>+<u>F7</u>	Activate standby (→ page 17)	—
<u>Fn</u>+<u>F8</u>	Concealed Mode on/off You can select on/off of LCD Backlight, LED, Sound ^{*2} , Wireless Radio, Camera Light, and Backlit Keyboard. NOTE <ul style="list-style-type: none"> You have to set [Concealed Mode] to [Enabled] in Setup Utility (→ page 88). You can set the devices turned off in [Concealed Mode] with Setup Utility (→ page 88). If you press <u>Fn</u>+<u>F8</u> in succession, the Concealed Mode may not be switched. More than 4 minutes interval is necessary to switch on/off. 	—
<u>Fn</u>+<u>F9</u>	Remaining battery charge	(→ page 25)
<u>Fn</u>+<u>F10</u>	Activate hibernation (→ page 17)	—

^{*1} These key combinations are disabled when [Concealed Mode] is enabled.

^{*2} Even if [Sound] is set to [OFF] on the [Concealed Mode Configuration] menu,  icon on the notification area and [Device volume] display do not show mute state. However, audio from the speaker is not heard.

Hotkey Settings

You can make 2 settings:

- **Fn key lock**
Fn is locked (pressed-down) until you press another key. Use this when pressing difficult key combinations.
- **Popup menu icon on/off**

1 Start up the Hotkey Settings.

Click [start] - [All Programs] - [Panasonic] - [Hotkey Settings].

2 Make the settings.



[Use Fn key lock]

- When using an **Fn** key combination
 - ① Press **Fn** once. (Locked)
 - ② Press another key. (Lock released)
- When using successive **Fn** key combinations
 - ① Press **Fn** twice. (Locked)
 - ② Press another key.
Fn key remains locked until you press **Fn** again.

[Notification]

[Make sounds when Fn key is pressed]*³

[Show status on screen]: Displays the Fn key status on the notification area.

-  **Fn** is locked.
-  **Fn** is not locked.

[Disable popup]





The popup menu icon will not be displayed.

3 Click [OK].

NOTE

- You can have different settings for each user.

*³ If the speaker is muted or [Sound] is turned off in [Concealed Mode Configuration], beeps do not sound.

Button	Function
	<p>LCD Brightness ▼: down / ▲: up</p>
	<p>Input Panel <Only for model with Windows XP Professional> Software keyboard on/off (→ page 11)</p> <p><Only for model with Windows XP Tablet PC Edition> Tablet PC Input Panel on/off</p> <ul style="list-style-type: none"> ● This button does not work on the Welcome screen.
	<p>Enter Works as <u>Enter</u>.</p>
	<p>Rotation Rotates the display. (→ page 14)</p> <ul style="list-style-type: none"> ● Do not press the button again until the display rotation is completed.
	<p>Security <Only for model with Windows XP Professional> Locks the computer.</p> <ul style="list-style-type: none"> ● On the Windows logon screen and the Welcome screen, this button work as <u>Ctrl</u> + <u>Alt</u> + <u>Del</u>. ● This button does not work on screensaver. <p><Only for model with Windows XP Tablet PC Edition> Works as <u>Ctrl</u> + <u>Alt</u> + <u>Del</u>.</p>

NOTE

- The Tablet buttons work when the Windows screen is displayed.
 - The Tablet buttons may not work immediately after Windows is started up or the Windows logon screen (or the Welcome screen) is displayed.
- <Only for model with Windows XP Professional>
- If you set password input for resuming from screensaver, the Input Panel, Enter and Rotation buttons do not work on screensaver.

Setting the Tablet Buttons

NOTE

- You can have different settings for each user.
- On the Windows logon screen and Welcome screen, the tablet buttons are enabled and work in default irrespective of the settings you made.

■ To change the tablet button functions

You can change the functions of the Input Panel () / Enter () / Rotation () buttons.

1 Open the setting screen.

<Only for model with Windows XP Professional>

Click [start] - [All Programs] - [Panasonic] - [Tablet Buttons Settings].

<Only for model with Windows XP Tablet PC Edition>

Click [start] - [Control Panel] - [Printers and Other Hardware] - [Tablet and Pen Settings] - [Tablet Buttons].

2 Click the tablet button and click [Change].

3 Select the function in [Action].

- You cannot select **Fn** for [Press a key or key combination].
- Click [Browse] to select the application if you select [Launch an application].

4 Click [OK].

5 Click [OK].

<Only for model with Windows XP Professional>

■ To disable the tablet buttons

You can disable the Security () / Input Panel () / Enter () / Rotation () buttons.

1 Click [start] - [All Programs] - [Panasonic] - [Tablet Buttons Settings].

2 Remove the check mark from [Enable Security, Input Panel, Enter, Rotation Button.]

3 Click [OK].

<Only for model with touchscreen>



You can use the touchscreen function to perform the same operation as the touch pad and mouse. Touch the screen surface with the stylus (included).

■ To right-click

1 Click  on the notification area.

 changes to .

2 Click the object you want to right-click.

 returns to .

NOTE

- Do not touch the screen by hand or other object when you input using the stylus (included). Otherwise you may not be able to input correctly.
- You need to make the following setting for each user.
 - ① Click [start] - [All Programs] - [Fujitsu Touch Panel (USB)] - [Touch Panel Configuration].
 - ② Select the settings, and then click [OK].
 - Do not add a check mark to [Delete Cursor] since the display may be distorted.
- If you add a check mark for [Use] in [Hold [Ctrl] key down + Touch the screen] of [Touch Panel Configuration], touching the screen may always be recognized as a right-click. To return to the normal operation, press **Ctrl** on the keyboard.
- The touchscreen function does not work in the Setup Utility, in the full screen of [Command Prompt].

Touchscreen Calibration

1 Run [Touch Screen Calibration Utility].

Click [start] - [All programs] - [Fujitsu Touch Panel (USB)] - [Touch Screen Calibration Utility].

2 Using the stylus, touch each of the 12 “+” target marks one by one until it blinks, and then press **Enter**.

3 Press **Enter**.

NOTE

- Return the rotated display to [0 degree] (→ [page 14](#)) before the touchscreen calibration.
- Perform the touchscreen calibration for each user.

<Only for model with dual touch>

You can use the digitizer function to perform the same operation as the touch pad and mouse by touching the screen surface with the digitizer pen (included). And you can use the touchscreen function to perform the same operation as the touch pad and mouse by touching the screen with your finger.

For further information, click [start] - [All Programs] - [Get Going with Tablet PC].

When touching with the digitizer pen, the touchscreen function is disabled.

■ To right-click

- Touch and hold the object.
- Press and hold the button (A) of the digitizer pen (included), and then tap the object.

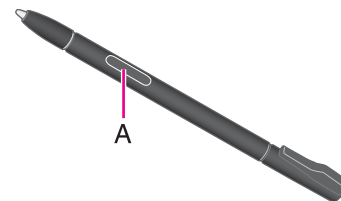

NOTE

- The dual touch function does not work in the Setup Utility, in the full screen of [Command Prompt].

Operation of the dual touch

■ Do not apply too much pressure when operating the dual touch

Only a light touch is required to operate the dual touch. Applying too much pressure may damage the surface.

Maintaining the performance of the dual touch

■ When the screen becomes dirty, wipe it with an approved soft cloth

The screen is specially treated to prevent dirt from adhering to the surface, so dirt can be removed easily using a dry cloth (use only the approved soft cloth). If the dirt does not come off easily, breathe on the surface and try again. Do not apply water or solvents to the soft cloth.

■ Wash the soft cloth when it becomes dirty

When the soft cloth becomes dirty, wash it with mild detergent. Do not use bleach or fabric conditioner (softener), or try to sterilize the cloth by boiling.

If the soft cloth is dirty, it may be ineffective in cleaning the screen, and in fact may cause dirt to adhere to the screen.

■ Check the following to prevent the surface of the screen from being scratched

- Is the surface clean?
- Is the soft cloth clean?
- Is the tip of the digitizer pen clean?

Things to keep in mind when using the dual touch

■ Do not apply excessive force to the screen

Do not lift the computer while holding the LCD screen, or allow the screen to be twisted. Do not place any objects on the LCD screen. Any of the above may cause the screen glass to break, or may damage the LCD screen.

■ If the cursor jumps to a location other than where the screen was touched, or if the LCD resolution changes, recalibrate the touchscreen

Perform the procedure of “Dual Touch Calibration” (below).

Dual Touch Calibration

NOTE

- Perform these calibration for each user.
- If you cannot touch the desired position, perform Digitizer Calibration again and restart the computer.

■ Digitizer Calibration

1 Run [Tablet and Pen Settings].

Double-click  or click [start] - [Control Panel] - [Printers and Other Hardware] - [Tablet and Pen Settings].

2 Click [Settings] - [Calibrate].

3 Using the digitizer pen, touch each of the 4 “+” target marks one by one, and then click [OK].

- Perform the calibration for both [Landscape] and [Portrait].

■ Touchscreen Calibration

Return the rotated display to [Primary Landscape] before the touchscreen calibration.

- 1 Run [Touch Settings].**
Click [start] - [Control Panel] - [Other Control Panel Option] - [Touch Settings].
- 2 Click [Calibrate...].**
- 3 Touch each of the 9 “+” target marks one by one, and then click [Finished].**
- 4 Restart the computer.**
 - Do not use the digitizer pen for touchscreen calibration.

Perform the calibration for the orientation to be used.

- 1 Run [Touch Settings].**
Click [start] - [Control Panel] - [Other Control Panel Option] - [Touch Settings].
- 2 Press Ctrl and click [Calibrate...].**
- 3 Touch each of the 4 “+” target marks one by one, and then click [Finished].**
- 4 Restart the computer.**

<Only for model with Windows XP Professional>

You can touch the screen keyboard using the stylus (included) to perform the same operation as the internal keyboard.

Starting the Software Keyboard

1 Press the Input Panel button (A).

- Alternatively you can click [start] - [All Programs] - [Panasonic] - [Software Keyboard].

2 Touch the software keyboard using the stylus.

- To use shortcut key
Example: **Ctrl + C**
Press **Ctrl** (turns blue) and then press **C**.
- To select the keyboard language, use the language bar (e.g. **EN**) on the notification area. If the keyboard language does not change, click the title bar of the software keyboard and then click on the application.
- Press the Input Panel button again to close the software keyboard.

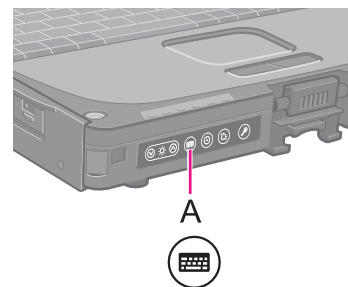

- A. Software keyboard menu (→ page 12)
- B. Moves the software keyboard to a corner of the screen.
- C. One tap : Works as shortcut key.
Two taps : Works as the key.
- D. Works as a right-click. (Same function as the key)

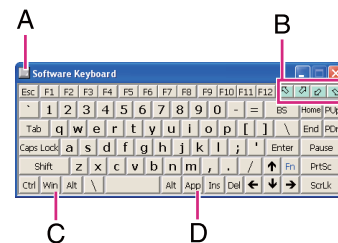

NOTE

- To use key combination (**Ctrl + C** etc.), use either of the internal keyboard or the software keyboard alone.
- You cannot use **Ctrl + Alt + Del** on the software keyboard after logging on.
- You cannot use the **Fn** key combination on the Windows logon screen and the Welcome screen.
- The software keyboard may not work during shutdown of Windows.
- You cannot use the software keyboard when the [Command Prompt] screen is set to “Full Screen”.
- You can set a different language to each application (⇒ Windows help), and the keyboard layout switches according to the application.
- Depending on the language, some keys are displayed in orange. You can use them to input characters such as **ë** and **ö**.

Software Keyboard Menu

1 Click  (A).

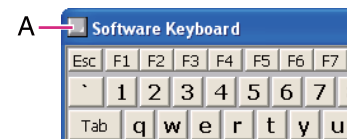

2 Add a check mark to the function you want to use.

- **[Auto Move]**
The software keyboard moves automatically to avoid overlapping the selected window.
- **[Auto Restore]**
The software keyboard minimized on the notification area will be restored when you change the input mode. This may not work on some applications.
- **[Always On Top]**
The software keyboard always appears on the top.
- **[Transparent]**
The software keyboard appears semi-transparent.
- **[Big Size]/[Medium Size]/[Small Size]**
Select the size of the software keyboard.
- **[Ten key (Big)]/[Ten key (Medium)]/[Ten key (Small)]**
Select the size of the numeric keypad.

NOTE

- You can change the currency symbol (B) of the numeric keypad.
Click [start] - [Control Panel] - [Date, Time, Language and Regional Options] - [Regional and Language Options] - [Regional Options] - [Customize] - [Currency] - [Currency symbol].
- After changing the currency symbol, click  (A), and then change the size of the numeric keypad so that the selected currency symbol is shown.

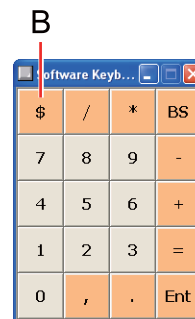

<Only for model with Windows XP Professional>

You can make a bitmap file (.bmp) of a simple character and a figure such as signature by handwriting on the touch pad and the touchscreen.

CAUTION

- Do not use the Fast User Switching function while Panasonic Hand Writing is active.
- If you install other pointing devices (e.g., commercially available mouse driver) and overwrite the touch pad driver, Panasonic Hand Writing will not work.

NOTE

- The display of Panasonic Hand Writing may be distorted if the number of display colors is changed. Right-click  on the notification area and click [Exit Panasonic Hand Writing], and then restart Panasonic Hand Writing.
- Panasonic Hand Writing may not work properly if another application software is active. In this case, close the application software and try handwriting again.

Starting Panasonic Hand Writing

1 Double-click on the notification area.

Alternatively you can click [start] - [All Programs] - [Panasonic] - [Panasonic Hand Writing].

NOTE

- Select the image size before handwriting by clicking [Option] - [Window size]. If you change the size after handwriting, the image quality will become lower.
- You can copy the bitmap image by clicking [Edit] - [Copy], and paste it in another application software that supports bitmap format.
- The touch pad mode will not work properly when using the extended desktop.
- The touch pad mode will not work properly when the display is rotated 90 or 270 degree.
- The touch pad mode will be canceled in the following cases.
 - Switching to another application
 - Resuming from standby or hibernation
 - Pressing **Alt**
 - Touching the touchscreen
- An external mouse or trackball connected via the keyboard/mouse port of the port replicator (optional) or the car mounter (optional) will not work during handwriting in the touch pad mode.

Rotating the Display

1 Press the Rotation button (A).

Each time you press the button, the screen display rotates counter-clockwise by 90°.

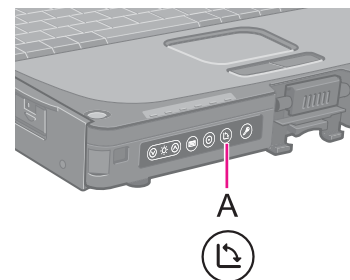

NOTE

- Alternatively you can rotate the display by the following procedure.
<Only for model with Windows XP Professional>
Double-click  on the notification area.
<Only for model with Windows XP Tablet PC Edition>
Click [start] - [Control Panel] - [Printers and Other Hardware] - [Tablet and Pen Settings] - [Display].
- While the display is rotated:
 - Do not use the Extended Desktop. The touch pad, touchscreen (only for model with touchscreen), or dual touch (only for model with dual touch) may not work properly.
 - Do not calibrate the touchscreen (only for model with touchscreen).
 - Do not set the resolution larger than that of the internal LCD.
 - The computer's performance is slightly lowered.
 - The touch pad scroll, zoom, and data zoom functions do not work.
- You cannot rotate the display when the [Command Prompt] is set to "Full Screen".
<Only for model with Windows XP Professional>
 - When the display is rotated, the motion video may not be displayed correctly or the sound may be distorted. Return the display angle to 0°.
 - When you set the resolution to 800 x 600 pixels and rotate the display, the resolution shown in [Screen resolution] of [Display Properties] may not correspond to the correct resolution. This is not a problem.
<Only for model with Windows XP Tablet PC Edition>
 - When the display is rotated, the motion video may not be displayed correctly or the sound may be distorted. Return the display angle to [Primary Landscape].
 - When you set the resolution to 800 x 600 pixels, you can rotate the display to [Primary Landscape] and [Secondary Landscape] only.

Changing the Settings

- 1 Right-click  on the notification area and click [Setting].**
The Display Rotation Tool screen appears.
- 2 Change the settings.**
- 3 Click [OK].**

NOTE

- In the following cases, the display angle automatically returns to the default angle.
 - When starting up Windows
 - When switching the Laptop mode and Tablet mode
 - When switching the logon user by the Fast User Switching function
- <Only for model with Windows XP Tablet PC Edition>
- You can set the order of display rotation positions in the following menu.
[start] - [Control Panel] - [Printers and Other Hardware] - [Tablet and Pen Settings] - [Display] - [Change]

The standby or hibernation function allows you to shut off the computer without closing programs and documents. You can quickly return to the programs and documents that you were working on before standby or hibernation.

Function	Data is saved to	Recovery time	Power supply
Standby	Memory	Short	Required. (If power is not supplied, all data will be lost.)
Hibernation	Hard disk	Rather long	Not required. (However power is slightly consumed to keep the hibernation.)

Setting Standby or Hibernation

- 1 Click [start] - [Control Panel] - [Performance and Maintenance] - [Power Options] - [Advanced].
- 2 Click [Stand by] or [Hibernate] for [When I close the lid of my portable computer:] / [When I press the power button on my computer:], and then click [OK].

NOTE

- You do not need to make the setting if you use the Windows menu to enter standby or hibernation.

Precautions

- Connect the AC adaptor if the computer will be in standby mode for a long period of time. If you cannot use the AC adaptor, use hibernation instead.
- Using standby or hibernation repeatedly may cause malfunction of the computer. To stabilize computer operation, restart Windows regularly (about once a week) without using standby or hibernation.
- Save the necessary data.
- Close files you have opened from removable disk and network drive.
- The password you set in the Setup Utility is not requested at resuming. You can use the Windows password for security in standby or hibernation.
 - ① Click [start] - [Control Panel] - [User Accounts], and select the account.
 - ② Click [Create a password] and set the password.
 - ③ Click [start] - [Control Panel] - [Performance and Maintenance] - [Power Options] - [Advanced], and add the check mark in [Prompt for password when computer resumes from standby].

- Do not enter standby or hibernation in the following conditions, otherwise the data or file may be corrupted, standby or hibernation may not work, or malfunction may occur in the computer or the peripheral devices.
 - When the hard disk drive indicator  or the SD Memory Card indicator is on.
 - When playing/recording audio files or displaying motion video such as MPEG files.
 - When writing to a disk.
 - When using communication software or network functions.
 - When using a PC Card.
(If the card fails to work normally, restart the computer.)
 - When an external mouse is connected to the serial port.
- The computer does not enter standby or hibernation immediately after resuming. Wait approximately one minute.

Entering/Resuming from Standby or Hibernation

■ To enter standby or hibernation

1 Close the display, or slide the power switch (A) until a beep^{*1} sounds.

Standby: The power indicator (B) blinks green.

Hibernation: The power indicator (B) goes off.

- You can alternatively use the Windows menu to enter standby or hibernation. To enter standby, click [start] - [Turn Off Computer] - [Stand By]. To enter hibernation, click [start] - [Turn Off Computer], then press and hold **Shift** and click [Hibernate].

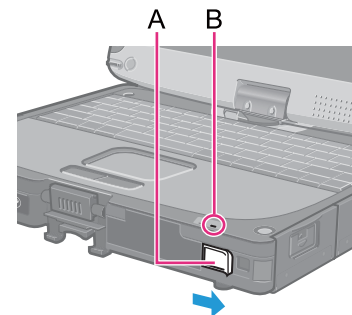

CAUTION

While the computer is entering standby or hibernation

- Do not:
 - Touch the keyboard, touch pad, touchscreen (only for model with touchscreen), dual touch (only for model with dual touch), tablet buttons, or power switch.
 - Use an external mouse or other peripheral device.
 - Connect or disconnect the AC adaptor.
 - Close or open the display.

Wait until the power indicator blinks green (standby) or goes off (hibernation).

- It may take one or two minutes to enter standby or hibernation.
- At the beep^{*1}, immediately release the power switch. If you slide and hold the power switch for longer than four seconds, the computer will forcibly shut down and unsaved data will be lost even if you have set [Shut down] in [When I press the power button on my computer:] (→ page 16 “Setting Standby or Hibernation”).

^{*1} If the speaker is muted or [Sound] is turned off in [Concealed Mode Configuration], beeps do not sound.

In standby or hibernation

- Do not attach or remove a peripheral device. Doing so may cause malfunction.
- Power is consumed in standby mode. Power consumption may increase when a PC Card is inserted. When power is exhausted, the data retained in memory will be lost. Connect the AC adaptor when using the standby function.

■ To resume from standby or hibernation

1 Open the display, or slide the power switch (A).

- When [Stand by] or [Hibernate] is selected as the setting for [When I close the lid of my portable computer] (→ [page 16](#)), you can resume operation opening the display. Note however opening the display does not work in the Tablet mode.

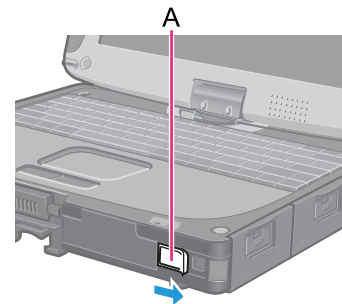

CAUTION

- Do not perform the following operations until resuming is complete. After the display has resumed, wait approximately 30 seconds (normally) or 60 seconds (when the computer is on a network).
 - Touch the keyboard (except for password input), touch pad, touchscreen (only for model with touchscreen), dual touch (only for model with dual touch), tablet buttons, or power switch.
 - Use an external mouse or other peripheral device.
 - Connect or disconnect the AC adaptor.
 - Close or open the display.
 - Shut down or restart Windows.
 - Enter standby or hibernation.

You can extend battery life and save power also during AC adaptor usage.

Reducing Power Consumption

Use the methods below to reduce power consumption.

- **Change [Power Options]**

Click [start] - [Control Panel] - [Performance and Maintenance] - [Power Options] to select [Max Battery] under [Power schemes]. While [Portable/Laptop] is selected under [Power Options] as the factory default, selecting [Max Battery] will further reduce power consumption.

Also, make detailed settings such as reducing the time entered in the [Turn off monitor] setting.

- **Use Power Saving Utility** → [page 20](#)

Power Saving Utility provides additional power saving functions not available in [Power Options].

- **Press **Fn** + **F1** to reduce LCD brightness**

Reducing internal LCD brightness will reduce power consumption.

- **Turn off the computer when it is not in use**

You can also turn off only the wireless LAN or Bluetooth power.

- **Disconnect external devices (USB devices, PC cards, external mice, etc.) that are not being used**

- **Use Standby/Hibernation**

Press **Fn** + **F7** to set the computer to standby or **Fn** + **F10** to set it to hibernation when you have to leave the computer. This shuts down computer operation to reduce power consumption.

Disable Wake Up from wired LAN and Wake Up from wireless LAN functions when they are not needed. This reduces power consumption in Standby/Hibernation.

To confirm current settings, click [start] - [All Programs] - [Panasonic] - [Power Saving Utility] to view [Wired LAN standby power saving function] or [Wireless LAN standby power saving function].

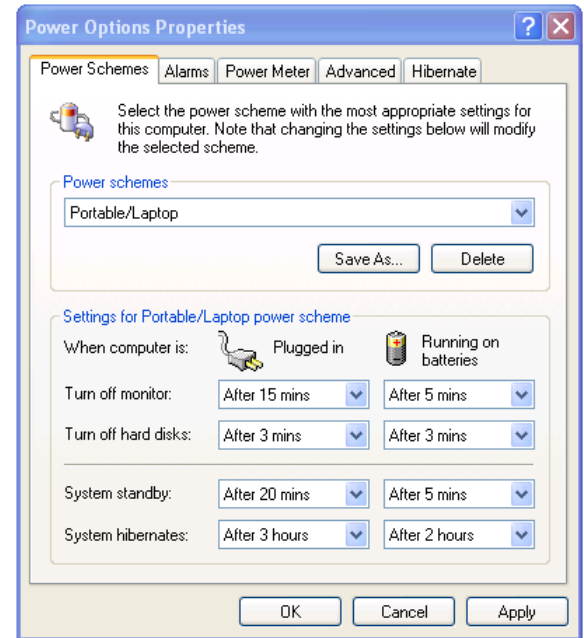

Using Power Saving Utility

A single setting allows you to enable all the following power saving features. Enable each of these functions to prolong battery operation time.

- **Intel video driver power saving function (Intel(R) Display Power Saving Technology)**
This function adjusts video contrast, color and other factors to lower internal LCD power consumption while retaining adequate image quality.
Disable this function for work that requires subtle image and color nuances or in video editing using video editing applications.
- **Wired LAN standby power saving function**
Enabling this function disables the Wake Up from wired LAN function to save power in standby/hibernation.
Disable this function if you want to use the Wake Up from wired LAN function.
- **Wireless LAN standby power saving function**
Enabling this function disables the Wake Up from wireless LAN function to save power in standby/hibernation.
Disable this function if you want to use the Wake Up from wireless LAN function.

■ Setup

- 1 Click [start] - [All Programs] - [Panasonic] - [Power Saving Utility].
- 2 Click [Enable] for each function.

Click [OK] in the confirmation screen that appears.

- **To enable “Intel video driver power saving function”**
Select [Enable], and slide the slide bar to the “Maximum Battery” end.

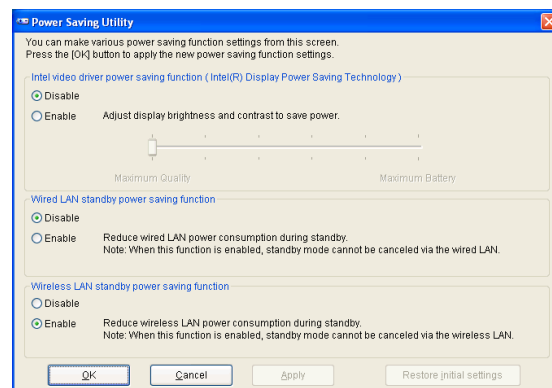

3 Click [OK].

Click [Restore initial settings] to return to the factory default settings, and click [OK].

NOTE

- You can also enable the Intel video driver power saving function as follows.
 - ① Click [start] - [Control Panel] and click [Other Control Panel Options] under [See Also] on the left side of the screen and select [Intel(R) GMA Driver for Mobile].
 - ② Click [Notebook], [Apply] and [OK].
 - ③ Click [Display Settings].
 - ④ Click [Power Settings].
 - ⑤ Click [Modify Settings].
 - ⑥ Click [Intel(R) Display Power Saving Technology] to add a check mark.
 - ⑦ Move the slide bar to [Maximum Battery] and click [OK].
 - ⑧ Click [OK].

There is no need to reboot the computer.
- For how to enable/disable the Wake Up from wired LAN function (→ [page 72](#))
For how to enable/disable the Wake Up from wireless LAN function (→ [page 81](#))

Use these features to protect your data.

- Another security measure
 - Embedded Security (TPM) (→ [page 92](#)): For further information, refer to the *Installation Manual* of “Trusted Platform Module (TPM)”.

Setting the Supervisor Password/User Password

Set the Supervisor Password before setting the User Password.

- 1 Start up the Setup Utility (→ [page 85](#)).**
- 2 Select [Security].**
- 3 Select [Set Supervisor Password] or [Set User Password], and press Enter.**
- 4 Enter your password in [Create New Password] and press Enter.**
 - When the password has been set, you need to enter your password in [Enter Current Password] and press Enter.
 - To disable the password, leave the input field empty and press Enter.
- 5 Enter your password again in [Confirm New Password] and press Enter.**
- 6 Press F10, and then select [Yes] and press Enter.**

CAUTION

- Do not forget your password. If you forget your Supervisor Password, you will not be able to use your computer. Contact Panasonic Technical Support.
- When running the Setup Utility, do not leave and go away from your computer even for a short time, since other people may set or change the password.

NOTE

- The password will not be displayed on the screen.
- You can use up to 32 alphanumeric characters (including spaces).
 - The case (upper/lower) is ignored.
 - To input numbers for the password, you cannot use the numbered keys on the keyboard.
 - You cannot use **Shift** and **Ctrl** to input a password.
- Disabling the Supervisor Password also disables the User Password.

Preventing Your Computer from Unauthorized Use

You can set a start-up password to protect your computer from unauthorized use.

- 1 **Set the password (→ page 22), and select [Enabled] in [Password on boot] in the [Security] menu of the Setup Utility (→ page 92).**

NOTE

- If the Supervisor Password or User Password has been set, the password input screen will be displayed on starting-up of the Setup Utility even though [Password on boot] is set to [Disabled].

Preventing Your Hard Disk Data from Being Read or Written

The hard disk lock function protects the hard disk data from being read or written when the hard disk is attached to another computer. The data can be read/written when the hard disk is returned to the original computer. (Note that the hard disk lock does not guarantee complete protection of the data.)

- 1 **Select [Enabled] in [Hard Disk Lock] in the [Security] menu of the Setup Utility (→ page 92).**

CAUTION

- For the data being read/written on the original computer, the Setup Utility settings must be the same as when the hard disk was removed.
- You cannot use the hard disk lock function without setting the Supervisor Password. Set the Supervisor Password beforehand (→ page 22).
- When you have your hard disk drive repaired
 - Contact Panasonic Technical Support.
 - Before sending back the hard disk drive, be sure to set the [Hard Disk Lock] to [Disabled].

NOTE

- The hard disk lock function works with the built-in hard disk. It does not work with the external hard disk.
- We recommend you to set [Password on boot] to [Enabled] to ensure security though it is not required to enable the hard disk lock.

Battery Indicator

Battery indicator	Battery status
Not lit	The battery pack is not inserted or not being charged.
Orange	Charging is in progress.
Green	The battery is fully-charged.
Blinking green	In high temperature mode, the battery pack is discharging the power to 80% ^{*1} of normal temperature mode (→ page 26). Do not remove the battery pack in this status.
Red	The remaining battery is approximately 9% or less.
Blinking red	The battery pack or the charging circuit is not operating properly.
Blinking orange	The battery cannot be charged temporarily due to the following reasons: <ul style="list-style-type: none">• Its internal temperature is out of the acceptable range.• The power supply is not enough because software applications or peripheral devices are consuming a large amount of power.
Blinking green and orange alternately	The temperature is low and the computer is warming up to prevent the hard disk drive from malfunctioning. The computer will start automatically after warming-up.
Blinking orange slowly	When you set [Battery Charging Indicator] to [Flashing] on the [Main Menu] of [Setup Utility].

*1 In high temperature mode, the 100% battery level is equivalent to 80% level of the normal temperature mode.

NOTE

- Once the battery is fully charged, the computer performs recharging only when the battery level becomes less than approximately 95%, so overcharging is avoided.
- When [LED] is set to [OFF] on the [Concealed Mode Configuration] menu, LED disappears. (→ page 88)

Checking the Remaining Battery Charge

You can check the remaining battery charge on the screen.

(After logging on to Windows)

1 Press **Fn+F9**.

- When the battery pack is inserted (example)



: Normal temperature mode (→ [page 26](#))



: High temperature mode (→ [page 26](#))

- When the battery pack is not inserted



NOTE

- The battery display may not correspond to the actual remaining battery charge in the cases as below. To correct the display, perform the Battery Recalibration (→ [page 28](#)).
 - The battery indicator remains red.
 - The indicator lights orange and the display shows 99% for a long time.
 - Low battery warning appears soon after a short time of use.
This can occur when the computer is in standby mode for a long time without power supply from the AC adaptor.
- The battery display may not be the same as that of notification area or of [Power Meter] in [Power Options Properties]. This is not a malfunction.

High temperature mode

The high temperature mode can prevent the battery from deteriorating when the computer is used in high-temperature environment or used for a long time with its battery fully charged.

Select [Auto] (default) or [High Temperature] in [Environment] of the [Main] menu of the Setup Utility (→ [page 88](#)).

NOTE

- Note that a level corresponding to a 100% charge for high temperature mode is approximately equivalent to an 80% charge level for normal temperature mode.
 - After switching from [Normal Temperature] to [High Temperature] or vice versa, the remaining battery capacity will not be displayed correctly until the battery pack is completely discharged or fully charged.
 - In the [Auto] mode:
Once the computer has automatically switched from the normal temperature mode to the high temperature mode, the computer will not switch back to the normal temperature mode until the battery has been used and recharged to a total charge level of about 5 times as much as that of the fully-charged state. This is to avoid battery deterioration.
-

Computer behavior with low battery

The default settings are as follows.

When the battery level becomes 10% [Low battery alarm]	When the battery level becomes 5% [Critical battery alarm]
<ul style="list-style-type: none">● Displays a message that the battery level is low. <p style="text-align: center;">↓</p>	<ul style="list-style-type: none">● Displays a message that the battery level is low, and then the computer enters hibernation. <p style="text-align: center;">↓</p>
Charge the battery.	Connect the AC adaptor or replace the battery to start up the computer.
<ul style="list-style-type: none">● Connect the AC adaptor immediately. If you do not have the AC adaptor, exit the running programs and Windows, then confirm that the power indicator is off.● If you have a fully charged spare battery, turn off the computer, replace the battery and turn the computer on again.	<ul style="list-style-type: none">● Connect the AC adaptor and charge the battery.● If you have a fully charged spare battery, replace the battery and turn the computer on again. <p>When the computer enters hibernation with the battery down and you resume the operation without charging the battery, Windows may not start up normally or the alarm function may not operate normally from then on.</p>
Do not replace the battery pack when the computer is in standby mode.	

Correcting the Battery Display (Battery Recalibration)

The “Battery Recalibration” function measures and memorizes the battery capacity. To correct the battery display, use this function to fill the battery and then discharge it completely. Perform the procedure at least once immediately after purchasing the computer. Normally the interval of battery recalibration is 3 months. The battery display may not be correct when the battery pack deteriorates after a long time use. In this case, perform the procedure again.

1 Connect the AC adaptor.

2 Close all the applications.

3 Perform “Battery Recalibration”.

- ① Click [start] - [All Programs] - [Panasonic] - [Battery] - [Battery Recalibration].
- ② When the confirmation message appears, click [Start].
 - Frequent recalibration of the battery can degrade the battery. A caution message appears when the battery recalibration is performed at the shorter interval than approximately a month. In this case, cancel the battery recalibration.
- ③ When the message requests shut down of Windows, click [Yes].

The battery recalibration starts.

After the battery pack is fully charged, discharging starts. When the discharging is completed, the power goes off automatically.

After the battery recalibration is finished, normal charging starts.

NOTE

- The temperature range should be 10°C to 30°C {50°F to 86°F}.
- The battery recalibration may take a long time due to the large battery capacity. This is not a malfunction.
 - Full charge: Approximately 4.5 hours [max.]
 - Complete discharge: Approximately 4.5 hours
- If the computer is turned off during the battery recalibration (e.g., due to power failure, or accidental removal of the AC adaptor and battery pack), the battery recalibration will not be completed.
- You can also perform the battery recalibration with the following procedure.
 - ① Restart the computer.
 - ② Press and hold **F9** while the [Panasonic] boot screen is displayed just after the computer starts the startup procedure.
 - ③ When the remaining battery capacity is displayed, press **Enter**.
 - ④ Follow the on-screen instructions.

Replacing the Battery Pack

The battery pack is a consumable item so the replacement will be necessary. If the battery operation time becomes noticeably short and not recovered even after recalibrating the battery, replace with a new battery.

CAUTION

- The battery pack is not charged when you first purchase it. Be sure to charge it before using for the first time. Charging starts automatically when the AC adaptor is connected to the computer.
- Use only the specified battery pack with your computer.
- In the standby mode, do not remove/replace the battery pack. Otherwise your data will be lost and the computer may be damaged.

1 Turn off the computer.

- Do not use the standby function.

2 Remove/Insert the battery pack.

- To remove
 - ① Slide the latch (A) to the right to unlock the cover.
 - ② Slide the latch (A) down, and open the cover.

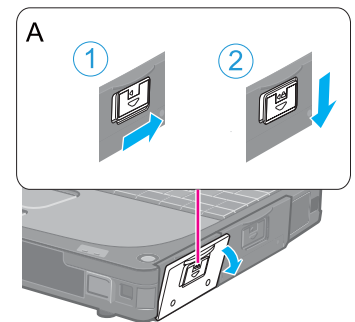

- ③ Pull the tab (B) of the battery pack.

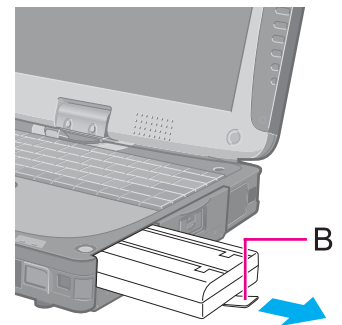

- To insert
- ① Insert the battery pack until it securely fits the connector.

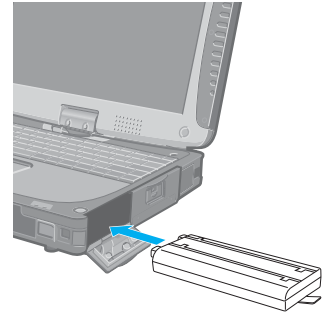

- ② Close the cover until it clicks.
- ③ Slide the latch (C) to the left to lock the cover.

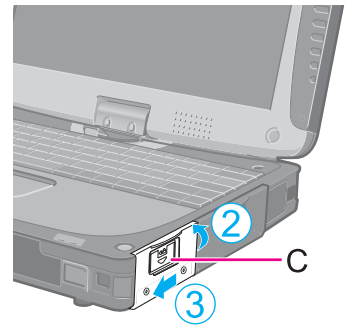

CAUTION

- Make sure the latch is securely locked, otherwise the battery pack may fall when you carry the computer.

You can insert the following cards.

- ExpressCard/34 or ExpressCard/54 to the ExpressCard slot (A)
(Only for model with ExpressCard slot)
- PC Card Type I (3.3 mm) or II (5.0 mm) to the PC Card slot (B)
- For model with Smart Card slot (→ [page 37](#))



NOTE

- The following types of card are not supported:
PC Card Type III (10.5 mm), ZV card, SRAM card, FLASH ROM card (excluding ATA interface type), and other cards that require 12 V of operating voltage.
- Dummy cards are inserted into both of the slots at the factory.
First remove the dummy cards. (→ [page 38 Step 1](#))
- Be sure to insert each dummy card when the slots are not in use.
- Insert the appropriate dummy card in the correct card slot. Insert the dummy PC Card in the PC Card slot, and the dummy ExpressCard in the ExpressCard slot.
Inserting a dummy card in the wrong slot may cause malfunction of the computer.

Inserting/Removing the Card

■ To insert the card

1 Open the cover.

- ① Slide the latch (C) to the right to unlock the cover.
- ② Slide the latch (C) down, and open the cover.

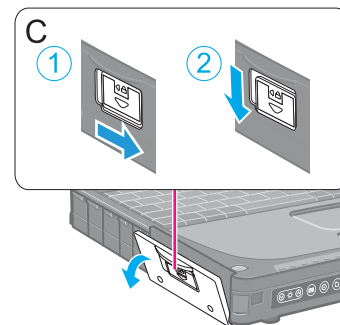

2 Insert the ExpressCard (upper slot) (D) or the PC Card (lower slot) (E) with the label side up until it securely fits in to the slot.

- For further information, refer to the instruction manual of the card.

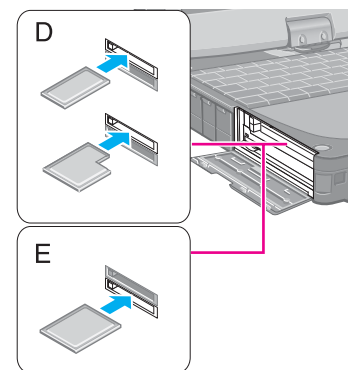

NOTE

<Only for model with Smart Card slot>

- The upper slot (D) is the PC Card slot, and the lower slot (E) is the Smart Card slot. Express Cards cannot be used. For how to insert/remove a Smart Card: (→ [page 37](#))

■ To remove the card

1 Disable the card function.

- ① Double-click  on the notification area and select the card, then click [Stop].
- ② Follow the on-screen instructions.
 - This step is not necessary when removing the card after turning off the computer.

2 Open the cover and remove the card.

- ① Press the eject button (F). The eject button pops out.
- ② Press the eject button (F) again so the card comes out of the slot.
- ③ Draw the card straight out.

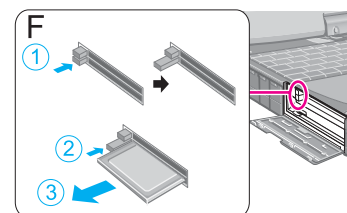

NOTE

- Check the card's specification to prevent the total operating current from exceeding the allowable limit. Otherwise malfunction may occur.
Permissible Current: 3.3 V: 400 mA, 5 V: 400 mA
- Some types of cards cannot be used simultaneously.
- After repeating insertion and removal, some types of card will not be recognized. In this case, restart the computer.
- If the computer freezes after resuming from standby or hibernation, remove and reinsert the card. If the problem persists, restart the computer.
- When a card is inserted, power consumption increases. Remove the card when it is not in use, especially when operating by battery power.
- To connect peripheral devices (SCSI, IEEE 1394, etc.) using a PC Card or an ExpressCard, follow the steps below (one example).
 - ① Connect the peripheral device to the card.
 - ② Turn on the power of device.
 - ③ Insert the card until it surely fits in the slot.

SD Memory Card Information

- The SD Memory Card has a copyright protection function which is compatible with content on-demand services on the Internet, etc.
- To format the SD Memory Card on this computer, do not use [Format] of Windows, but use the SD Memory Card format software.
You can download the software from the web site below.
http://panasonic.jp/support/global/cs/sd/download/sd_formatter.html
- To use the SD Memory Card on other devices, format the card on those devices. For further information, refer to the instruction manual of the devices.
- This computer supports SDHC Memory Cards (SD Memory Cards with a capacity of more than 2 GB).

Handling and storage cautions

- Store the SD Memory Card in the case after removing it from the computer.
- Do not:
 - Disassemble or modify the card.
 - Hit, bend, or drop the card.
 - Touch the terminals with fingers or metal object.
 - Remove the labels of the card / Attach other labels or stickers to the card.
- Do not place the card in the following locations.
 - In direct sunlight or in very hot location such as inside of a car.
 - In very dusty or humid location.
 - In location subject to corrosive gas, etc.

Data handling cautions

- Set the write-protect switch (A) to the LOCK position. Unlock the switch when recording (checkout), saving, or editing data.
- We recommend you to back up the important data to another storage medium.
- When disposing the card, we recommend you to physically destroy the card (using a hammer, etc.) to prevent personal or confidential data leakage.

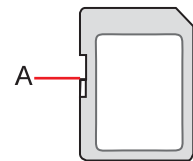

Inserting/Removing the SD Memory Card

CAUTION

- Do not remove or insert the SD Memory Card until Windows has completed loading.
- Do not remove the card or turn off the computer in the following cases, otherwise the data may be corrupted.
 - While the computer is in standby or hibernation.
 - Immediately after the writing operation.

The computer may still continue the access to the card just after writing operation. If you remove the card before the operation is completed, the data may be damaged or the card access may no longer be performed normally.
- Note that Panasonic assumes absolutely no liability for any loss of data recorded by the user, or any other damages, direct or indirect.
- Do not forcibly draw out the card, otherwise the slot may be damaged.
- Insert the card in the correct direction, otherwise the card and the slot may be damaged.
- After resuming from standby or hibernation, do not access the SD Memory Card for approximately 30 seconds.

■ To insert the card

1 Open the cover.

- ① Slide the latch (A) to the right to unlock the cover.
- ② Slide the latch (A) down, and open the cover.

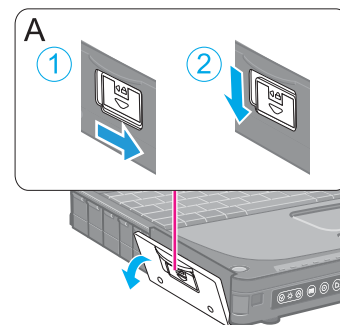

2 Insert the SD Memory Card with the label side facing up and with the cut corner facing in.

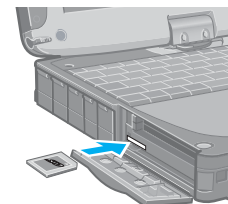

■ To remove the card

Preparation

- Save the data and close all applications.
- Open the cover and confirm the SD Memory Card indicator (B) is off.

1 Disable the card function.

- ① Double-click  on the notification area and click [Secure Digital Storage Device], then click [Stop].
- ② Follow the on-screen instructions.
 - This step is not necessary when removing the card after turning off the computer.

2 Remove the card.

- ① Press the card so it comes out of the slot.
- ② Draw it straight out.

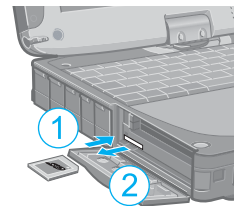
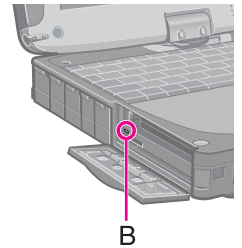

<Only for model with Smart Card slot>

You need software to use a Smart Card.

You can insert the following cards.

- PC Card Type I (3.3 mm) or II (5.0 mm) to the PC Card slot (A)
- Smart Card to the Smart Card slot (B)



CAUTION

- Do not:
 - Hit, bend, or drop the card.
 - Touch the contact part with fingers or metal object.
 - Place the card in very hot location for a long time.
 - Remove the card immediately after inserting it.

Inserting/Removing the Smart Card

■ To insert the card

1 Open the cover.

- ① Slide the latch (A) to the right to unlock the cover.
- ② Slide the latch (A) down, and open the cover.

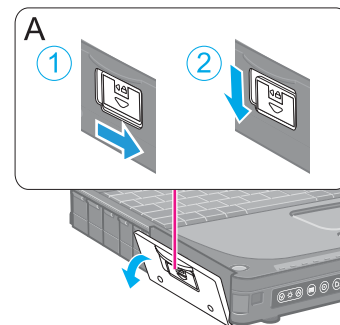

2 Inset the Smart Card to the lower slot (B) with the contact part (C) in front.

- Insert the card until it securely fits into the slot.

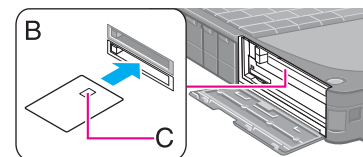

■ To remove the card

- 1 Open the cover and draw the card straight out.

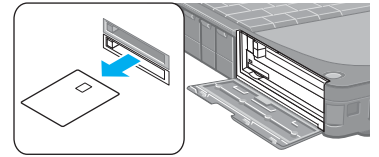

Use RAM modules that comply with the specifications below. Using any other module may cause malfunction or result in computer failure.

RAM module specifications:

200 pins, SO-DIMM, 1.8 V, DDR2 SDRAM, PC2-5300

(For information of RAM module compatibility, contact Panasonic Technical Support.)

CAUTION

- RAM modules are extremely sensitive to static electricity and can be affected even by static electricity from the human body. When inserting and removing RAM modules, do not touch the terminals or internal components, and do not allow foreign particles to enter the slots. Doing so may cause damage, fire, or electric shock.

Inserting/Removing the RAM Module

- 1 Turn off the computer.**
 - Do not use standby or hibernation.
- 2 Disconnect the AC adaptor and remove the battery pack (→ [page 29](#)).**
- 3 Remove the screws (A) and the cover (B) on the bottom of the computer.**

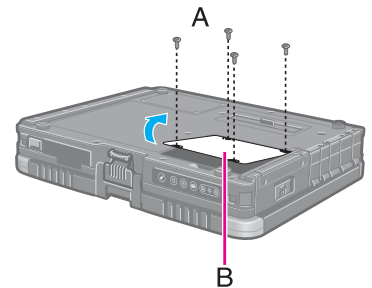

4 Insert/Remove the RAM module.

- To insert
 - ① Tilt the module slightly and insert it in the slot.
 - ② Press down the module so that the right and left hooks (C) are locked.

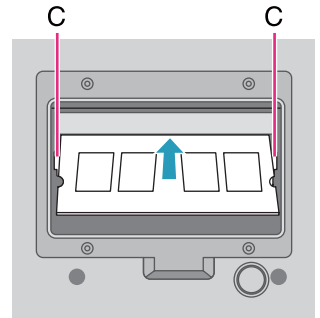

- To remove
 - ① Carefully open the right and left hooks (C). The module will rise.
 - ② Carefully remove the module from the slot.

5 Set the cover and battery pack.

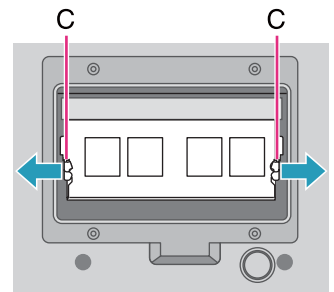

NOTE

- If it is hard to insert or to press down the RAM module, do not try forcibly but check the module's direction.
 - Use the appropriate screw driver so as not to strip the head of screw.
 - If the RAM module is recognized correctly, the total size of the RAM module memory is displayed on the [Information] menu of the Setup Utility (→ [page 86](#)).
- If the RAM module is not recognized, power off the computer and insert it again.

You can use an optional port replicator and a car mounter. These devices free you from being bothered by a lot of cable connections when you carry the computer. They also allow you to connect various peripherals.

Connect the port replicator or the car mounter to the expansion bus connector (A) on the bottom side of the computer.

For further information, refer to the instruction manual of the port replicator or the car mounter.

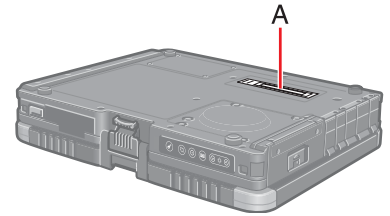

CAUTION

- The driver of the port replicator or the car mounter is preinstalled in the computer. Do not install the driver using the CD-ROM supplied with the port replicator or the car mounter.
- Make sure the slide cover is completely open.
- Hot or warm docking/undocking is not possible with the port replicator or the car mounter.
- To boot the computer from a USB floppy disk drive or a USB CD/DVD drive, be sure to connect the USB drive to the USB port on the computer, not to the USB port on the port replicator or the car mounter.

Using an External Mouse

When you connect an external mouse or trackball to the external keyboard/mouse port of the port replicator or the car mounter, some functions of the mouse or trackball (e.g. wheel function) will not work. To use the functions, perform the steps below.

After performing the steps below, some of the touch pad functions will not work.

NOTE

- You do not need to perform the following steps when using a USB mouse.

- 1** Click [start] - [Control Panel] - [Performance and Maintenance] - [System] - [Hardware] - [Device Manager].
- 2** Click [Mice and other pointing devices] and double-click [touchpad], and then click [Driver] - [Update Driver].
- 3** Click [No, not this time] and click [Next].
- 4** Click [Install from a list or specific location (Advanced)] and click [Next].
- 5** Click [Don't search. I will choose the driver to install.] and click [Next].

- 6 Click [PS/2 Compatible Mouse] and click [Next].
- 7 At the confirmation message, click [Yes].
- 8 Click [Finish] and click [Close].
- 9 When the message requests restart of Windows, click [Yes].
The computer will restart.

NOTE

- If you cannot use the functions of the external mouse and trackball even after the steps above, perform the steps below.
 - ① Turn off the computer and connect to the port replicator or to the car mounter.
 - ② Connect the external mouse or trackball to the port replicator or to the car mounter.
 - ③ Turn on the computer and start up the Setup Utility (→ [page 85](#)).
 - ④ Select the [Main] menu, and set [Touch Pad] to [Disabled].
 - ⑤ Press **F10**, and then select [Yes] and press **Enter**.
 - ⑥ Log on to Windows as an administrator.
 - ⑦ When [Completing the Found New Hardware Wizard] appears, click [Finish].
 - ⑧ When the message requests restart of Windows, click [Yes].
The computer will restart.
 - ⑨ Install the necessary driver following the operating instructions of the connected device.

You can switch the output destination to an external display.
Connect the external display to the external display port (A).

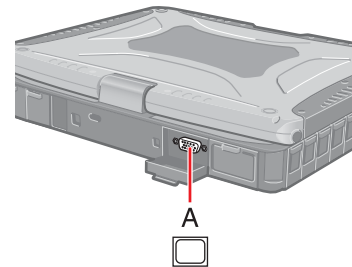

NOTE

- After resuming from hibernation or restarting the computer, the output destination may not be the same as the selected in the previous status.
- When you change the display after Windows starts up, do not press any key until switching is complete.
- Until Windows startup is completed (during Setup Utility, etc.), the simultaneous display cannot be used and pressing **Fn+F3** switches the display between the internal LCD and the external display.
- Display switching by pressing **Fn+F3** may not work when you use the Fast User Switching function to switch the user. In this case, log off all users and restart the computer.
- Display switching does not work when [Command Prompt] screen is set to “Full Screen”.
- When you use the external display only, set the suitable number of colors, resolution, or refresh rate separately from when you use the internal LCD only or when you use the simultaneous display. Depending on the settings, some external displays may be distorted or may not display the mouse cursor correctly. In this case, set the settings to lower value.
- When you use the simultaneous display, DVD-Video, MPEG files and other motion image files may not be played back smoothly.
- Carefully read the instruction manual of the external display.
- When connecting an external display that does not conform to the Plug & Play standards, select the display driver accordingly in the following menu, or use the driver disk supplied with the monitor.
[start] - [Control Panel] - [Appearance and Themes] - [Display] - [Settings] - [Advanced] - [Monitor] - [Properties] - [Driver] - [Update Driver]
- If a picture is not displayed normally, lower the level of [Hardware acceleration] in the following menu.
[start] - [Control Panel] - [Appearance and Themes] - [Display] - [Settings] - [Advanced] - [Troubleshoot]

CAUTION

- Before disconnecting the external display, switch to the internal LCD by pressing **Fn+F3**. Otherwise the displayed image quality may become different after disconnection (e.g., wrong resolution). In this case, press **Fn+F3** to reset the image quality.
- The screen may become distorted due to the following operations. In this case, restart the computer.
 - Disconnecting an external display for which you have set high resolution or high refresh rate.
 - Connecting/disconnecting an external display during computer operations.

Switching the Display

1 Press **Fn+F3**.

Each time you press the key combination:

Internal LCD → Simultaneous display → External display
↑

Extended Desktop

The extended desktop function allows you to use the working area across both the internal LCD and the external display. You can drag an object from the internal LCD to the external display and vice versa.

1 Display the [Intel(R) Graphics Media Accelerator Driver for mobile] screen.

Click [start] - [Control Panel] - [Other Control Panel Options] - [Intel(R) GMA Driver for Mobile] - [Display Devices].

2 Click [Extended Desktop], and make the settings for [Primary Device] and [Secondary Device].

3 Click [OK].

At the confirmation message, click [OK].

NOTE

- It may not be possible to use the extended desktop with some software applications.
- When you click the maximize button, the window is displayed on one of the displays. You cannot move the maximized window to the other display.
- You cannot switch the display by pressing **Fn+F3**.
- Do not use the display rotation in the extended desktop.
- The popup menu icon displayed by **Fn** key combination appears only on the primary device.
- Set the internal LCD to the primary device when using the touchscreen (only for model with touchscreen) or dual touch (only for model with dual touch). The cursor will move on the primary device when you touch the internal LCD.

Connecting/Removing USB Devices

■ To connect the USB device

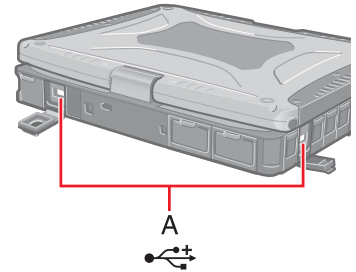

- 1 **Open the cover and connect the USB device to one of the USB ports (A).**

For further information, refer to the instruction manual of the USB device.



■ To remove the USB device

- 1 **Disable the USB device.**

- ① Double-click  on the notification area and select the USB device, then click [Stop].
- ② Follow the on-screen instructions.
 - This step is not necessary when;
 - Removing the device after turning off the computer.
 -  is not displayed.
 - The device does not appear in the list in step ①.

- 2 **Remove the USB device.**

NOTE

- You may need to install the driver for the USB device. Follow the on-screen instructions or refer to the instruction manual of the USB device.
- You may need to install the driver again when connecting the device to another port.
- When a USB device is connected, standby and hibernation may not function normally. If the computer does not start up normally, remove the USB device and restart the computer.
- When the USB device is removed and then inserted,  may appear in the Device Manager and the device may not be correctly recognized. In this case, remove and connect the device again.
- When the USB device is connected, power consumption increases. Remove the USB device when it is not in use, especially when operating by battery power.

You can connect a digital video camcorder or other IEEE 1394 standard device to the computer.

■ To connect IEEE 1394 device

- 1** Turn on the computer and the IEEE 1394 device.
- 2** Open the cover and connect the IEEE 1394 device to the IEEE 1394 interface connector (A).

For further information, refer to the instruction manual of the IEEE 1394 device.

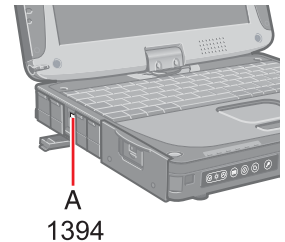

NOTE

- You may need to install the driver for the IEEE 1394 device. Follow the on-screen instructions or refer to the instruction manual of the IEEE 1394 device.

■ To remove IEEE 1394 device

CAUTION

- Turn off the IEEE 1394 device only after turning off the computer.

- 1** Turn off the computer and disconnect the cable from the IEEE 1394 interface connector.
- 2** Turn off the IEEE 1394 device and remove the cable.

<Only for model with Fingerprint Reader>

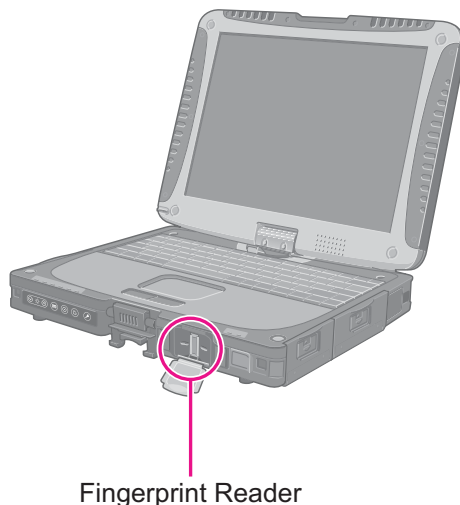

NOTE

- Enrollment and authentication is unavailable to an extremely minority of people including those whose fingerprints give little data for personal identification.

How to Use the Fingerprint Reader

This section explains how your fingerprints are enrolled and authenticated.

1 Slide your finger to the right or left.

- To prevent a reading error.
 - ① Set the first joint of your finger on the sensor as illustrated to the right.
 - ② Slide your finger to the right or left while keeping it in contact with the fingerprint sensor.
 - ③ Slide your finger to the right or left until the sensor is visible.
 - When the fingerprint sensor does not enroll or authenticate your fingerprint properly:
 - You slid your finger too fast or too slow.
 - Your finger was soiled or it has a scar on the surface.
 - Your finger was wet or extremely dry.
 - Your fingerprint does not have sufficient data for personal identification.
- For further information, refer to “Fingerprint Reader” (→ [page 113](#)).

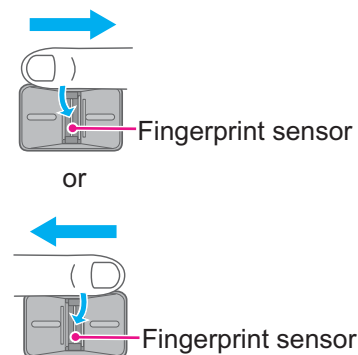

CAUTION

- To protect the fingerprint sensor, be sure to close the cover when not using the fingerprint reader.
- We shall not be liable for any loss or damage whatsoever resulting from your Fingerprint device or neglect of Fingerprint device use, or any data loss resulting from such developments as Fingerprint authentication device malfunctioning.

Overview

Fingerprint's Outline

The conventional security systems use ID/passwords and token devices such as IC cards to authenticate users. Therefore the passwords and token devices are exposed to the risk of being lost, stolen and hacking.

The Fingerprint authentication method uses user's fingerprints instead of passwords for security authentication. You can use your fingerprints to start up your computer and log on Windows.

We recommend you use the Fingerprint Reader in combination with the TPM (Trusted Platform Module) to increase the security level of your computer.

Recommended Installation Procedure

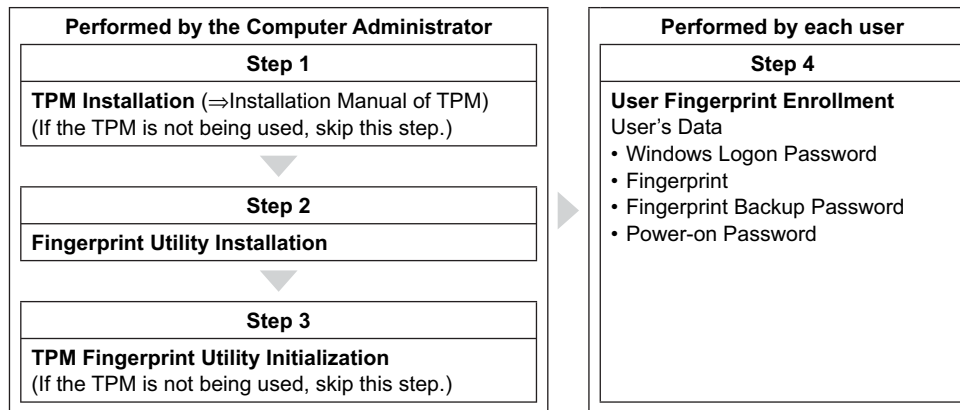

■ To access the online manual

This manual describes Step 2, 3 and the initial part of Step 4.
For further steps, refer to the UPEK Protector Suite QL Help menu.

- Click [start] - [All Programs] - [Protector Suite QL] - [Help].

Precautions

■ Security Functions

- Fingerprint Authentication Technology does not guarantee complete authentication and individual identification. Please acknowledge we shall not be liable for any loss or damage whatsoever resulting from the use of, or inability to use your Fingerprint device.
- The Fingerprint authentication method uses multiple fingerprints, encryption keys, credentials data and passwords. You might not be able to use your data if you lose fingerprints, keys, credentials and passwords. Back up the Fingerprint authentication data in a safe place. For further information, refer to “Backup” (→ [page 53](#)).
- General interaction with third-party applications: There is no guarantee that there will not be any negative interaction with any third-party software, and will not accept any responsibility for such an interaction.

Installation

1 TPM Installation

Refer to the *Installation Manual* of “Trusted Platform Module (TPM)”.

- Click [start] - [Run] and input “c:\util\drivers\tpm\readme.pdf”, and click [OK].

2 Fingerprint Utility Installation

Performed by the Computer Administrator.

- ① Log on to Windows as an Administrator.
- ② Close all other programs.
- ③ Click [start] - [Run], enter “c:\util\drivers\fnprint\install\setup32.exe”, and click [OK].
- ④ Click [Next].
Installation starts. Follow the on-screen instructions.
- ⑤ When the “Protector Suite *.* has been successfully installed.” message appears, click [Finish].
At the confirmation message, click [Yes].
The computer restarts.
- ⑥ Log on to Windows as an Administrator.
The “Protector Suite QL Icon”  appears in the notification area.

<Only for model with Tablet PC Edition>

Preparation

Move Tablet PC Input Panel from upper right to the bottom right or bottom left .

- If this procedure is skipped, the “Please swipe you finger” message may overlap the Tablet PC Input Panel.

3 TPM Fingerprint Utility Initialization

Performed by the Computer Administrator.

The “Invalid TPM status” message is displayed by the “Protector Suite QL Icon”  in the notification area.

- If the TPM is not being used, skip this step.
 - ① Click on the “Invalid TPM status” message to start [Advanced Security Initialization Wizard]. Follow the on-screen instructions.

NOTE

- If the “Invalid TPM status” message is not displayed
Click [start] - [All Programs] - [Protector Suite QL] - [Control Center] - [Settings] - [System Settings] - [TPM] - [Initialize TPM].

4 User Fingerprint Enrollment

Performed by each user.

- ① Click [start] - [All Programs] - [Protector Suite QL] - [User Enrollment].
Carefully read the License Agreement, select [I Accept the terms of the License Agreement] and click [OK].
- ② Click [Next].
- ③ Select an enrollment mode, and click [Finish].
 - Enrollment mode
You can make the configuration for the enrollment only once during this initialization phase.
 - Enrollment to the biometric device
All enrolled fingerprints are stored directly in the fingerprint sensor. The user data will be secured by the hardware protection keys obtained by the fingerprint sensor. This mode allows up to 21 fingerprints to be enrolled.
 - Enrollment to the hard disk
All enrolled fingerprints are stored on the hard disk. Hardware protection of the user data is not possible, but multiple users can enroll their fingerprints.
 - When the [Finish] screen appears, read the description carefully.
 - [User Enrollment] wizard starts. Follow the on-screen instructions.

NOTE

- Enroll at least two fingers. Even if one of them is injured, you can use another one to access your account and secret data. For further information about the enrollment, refer to “How to Use the Fingerprint Reader” (→ [page 47](#)) and [Fingerprint Tutorial].
 - Click [start] - [All Programs] - [Protector Suite QL] - [Fingerprint Tutorial].

- We recommend you use the Power-on Security feature. This feature prevents unauthorized access to the user's computer at the BIOS level.
After first finger enrollment, [Power-on Security] message appears. Select [Yes].
 - ① When the [Power-on Security] screen appears, click [Manage Passwords].
 - ② Select [Power-On] in [Password Types], and click [Set password].
 - ③ Enter the password for [Power-on Security], and click [OK].
 - ④ Click [Close].
 - ⑤ Add a check mark for [Power-On] in [Password Types].
 - ⑥ Enter the password (step ③), and click [OK].
 - ⑦ Click [Next].
 - Follow the on-screen instructions.

NOTE

- The number of fingerprints for [Power-on Security] is maximum of 21, because they are stored in the fingerprint sensor regardless of the selected enrollment mode.

More Advanced Security

You can increase your computer's security level by setting the BIOS level described in this section. Performed by the Computer Administrator.

1 Register the Supervisor Password.

You have to register the Supervisor Password to proceed to the next step.

If you have already registered the Supervisor Password, you can skip this step, and move on to step 2.

If you have not done this, have enrolled your fingerprint using Protector Suite QL, and have already made Power-on Security effective, after step 2, your fingerprint authentication will be necessary.

- ① Turn on or restart the computer.
- ② Press **F2** or **Del** while [Panasonic] boot screen is displayed soon after the computer starts the startup procedure.
- ③ Select the [Security] menu.
- ④ Select [Setup Supervisor Password], and press **Enter**.
- ⑤ Enter your password in the [Create New Password], and press **Enter**.
 - The password will not be displayed on the screen.
 - You can use up to 32 alphanumeric characters (including spaces).
 - The case (upper/lower) is ignored.
 - Use only the upper horizontal row of numeric keys to input your password.
 - You cannot use **Shift** and **Ctrl** to input a password.
- ⑥ Enter your password again in [Confirm New Password], and press **Enter**.

2 Set the High Security Level.

- ① Select [Fingerprint Security], and press **Enter**.
- ② Select [Security mode], and select [High].
 - Default setting: Simple
- ③ Press **Esc** to close the sub-menu.
- ④ Press **F10**, select [Yes], and press **Enter** to exit the Setup Utility.

NOTE

- In the [High] security mode, you have to enter the Supervisor or User Password even after fingerprint authentication. In the [Simple] security mode, you do not have to enter the Supervisor or User password after fingerprint authentication.

Useful Information

Backup

The file described below is necessary for recovering the Fingerprint authentication data. Back up this file periodically in a safe location such as removable disk to avoid data loss resulting from some accidents. We recommend you to store the file in a removable disk or network drive because the benefit of Fingerprint authentication security can be reduced if you keep the file in the internal hard disk drive.

The backup password described below is necessary for bypassing the Fingerprint authentication. We recommend you set the backup password using the [User Enrollment] wizard. If you do not define the backup password, you may lose your data in case of authentication hardware failure.

- File used by each user
 - Backup user passport data
(Default name: <UserAccount>.vtp)
You need this file when you replace the embedded fingerprint chip, or the hard disk drive, or when reinstalling Windows. This file contains the fingerprints, encryption keys, and logon authentication data.

NOTE

- How to Backup:
Select [Export] in [Import or Export User Data] to save the user data.
 - Click [start] - [All Programs] - [Protector Suite QL] - [Control Center] - [Fingerprints].
For further information, refer to the software's online manual ([→ page 48](#)).
- Password used by each user
 - Backup Password for Enrollment
This backup password can be used in case of hardware failure to bypass the fingerprint authentication.

CAUTION

- The passwords other than those explained above are also used for security, so do not lose them. For further information, refer to the software's online manual ([→ page 48](#)).
-

Limitations in Use

- Password Bank^{*1} limitations: The following web pages cannot be supported.
Web pages which are created by the following technologies:
 - Web forms created on the fly using javascript.
 - Web forms which looks as one form (e.g. login field, password field), but internally created with two independent forms.
 - There can be auto submit problems with web forms which do not have Submit button. All forms that you cannot submit with **Enter** will be entered by Password Bank, but not submitted.
 - Password Bank^{*1} limitations: The following Windows applications cannot be supported.
 - Applications which do not use standard Windows controls and draw controls by their own.
 - This includes any Java based application.
- ^{*1} For information of these functions, refer to the software's online manual (→ [page 48](#)).

Handling & Maintenance

- The enrolling and authentication sensitivity may decline under the conditions below. Wipe off stains or moisture on the sensor surface with a soft cloth.
 - The surface of the fingerprint sensor is soiled with dust, skin oil, or sweat.
 - The surface of the fingerprint sensor is wet as a result of moisture or condensation.
- Static electricity may also cause the sensor to malfunction. To make your finger static-free, touch a metal surface before placing it on the fingerprint sensor. Exercise caution against static electricity in winter and other dry conditions.
- Malfunction or damage may occur when:
 - The fingerprint sensor surface was damaged by the strong rubbing of a solid material, scratches, or being pecked with a pointed item.
 - The sensor was touched with a finger soiled with mud, damaging the sensor surface with a tiny substance, and staining the surface.
 - The sensor surface was covered with a seal, or soiled with ink.

Deleting (Initializing) Owner's Data

When you dispose of the computer or transfer the ownership, delete (initialize) the owner's data to avoid unauthorized access.

NOTE

- The data enrolled in the fingerprint sensor is not image data. You cannot restore fingerprint image data from the data enrolled in the fingerprint sensor.
-

1 Disable Power-on Security

- ① Log on to Windows as an Administrator.
- ② Click [start] - [All Programs] - [Protector Suite QL] - [Control Center].
 - The [Fingerprint Control Center] screen appears.
- ③ Click [Settings], and click [Power-on Security].
- ④ Remove the check mark from [Enable power-on security using fingerprints], and click [OK].
- ⑤ Click [Fingerprints], and click [Enroll or Edit Fingerprints].
 - [User Enrollment] wizard starts. Follow the on-screen instructions.
- ⑥ When the [User's Fingers] screen appears, click [Next] without deleting fingerprint samples.
- ⑦ Click [Manage Passwords].
- ⑧ Select [Power-On] in [Password Types], and click [Unset password].
- ⑨ Enter the password for Power-on Security, and click [OK].
- ⑩ Click [Close].
 - Confirm that there is no item in [Password Types].
- ⑪ Click [Next] - [Next].
- ⑫ Click [Finish].
 - Follow the on-screen instructions.

2 Delete Fingerprint Data.

Performed by each user.

- ① Click [Fingerprints], and click [Delete].
The [Swipe finger] screen will appear.
- ② Swipe user's finger.
 - If the authentication is successfully completed, the confirmation message appears.
- ③ Click [Yes].
 - Confirm that all users' data was deleted.

NOTE

- If the enrollment mode is set to "Enrollment to the hard disk" (→ [page 50](#)), you need to remove the fingerprints data after step 2. Performed by the Computer Administrator.
 - ① Click [start] - [All Programs] - [Protector Suite QL] - [Control Center].
 - ② Click [Settings], and click [Power-on Security].
 - ③ Select the fingerprint, and click [Remove].
 - Surely remove all of the fingerprints.

3 Uninstall Protector Suite

- ① Log on to Windows as an Administrator.
- ② Close all programs.
- ③ Click [start] - [Control Panel] - [Add or Remove programs].
- ④ Click [Protector Suite *.*], and click [Change].
- ⑤ Select [Remove].
- ⑥ Select [Remove all Protector Suite *.* data], and click [Next].
 - Uninstallation starts. Follow the on-screen instructions.
- ⑦ When the "Protector Suite *.* has been successfully uninstalled." Message appears, click [Finish].
 - If the confirmation message appears, click [Yes].
 - The computer restarts.

Starting Over

If the specific solutions for your problem in Fingerprint Reader (→ [page 113](#)) do not work, you can use these instructions as the last measure and start over. However, please note that you can lose your data - passwords, secret keys and fingerprints.

- ① Log on to Windows as an Administrator.
 - You can always access the computer by using your Windows log on password.
In convenient mode, any user can access the computer by using the Windows log on password.
- ② Try to export your passport to a file if you are planning to use your passwords, secret keys or enrolled fingers in the future.
 - If you exported your passport recently, this step is not required.
 - If biometrics authorization works and your finger is recognized, use [Import or Export User Data] wizard, swipe your finger and continue according to wizard's instructions.
 - If biometrics authorization works, but your finger is not recognized, you can start the [Import or Export User Data] wizard and export the passport even without using your fingerprint. You need to cancel fingerprint dialog, and you will be prompted for a password. If you do not use [Advanced Security], enter your Windows log on password. Otherwise, enter your [Advanced Security] backup password.

CAUTION

- If you used [Advanced Security] without a backup password. There is no way to backup your data.
 - If biometrics authorization does not work, there is no way to backup your data.
-

- ③ Deleting the passport.
 - Use the [Delete] wizard. Please note that all your stored secret data (passwords, [File Safe] encryption keys) will be lost. If you backed up the data, you can restore it in the next step; otherwise it will be lost permanently. To perform the delete operation it is necessary to cancel the fingerprint verification operation to get to the password dialog, then enter your Windows log on password or backup password.
- ④ Make sure your fingerprint sensor is working.
 - Use the Tutorial wizard to verify that the fingerprint sensor works. If not, reboot and try again. If it still does not work, please contact Panasonic Technical Support.
- ⑤ Restore or create passport.
 - If you have a backup of your data, you can now use [Import or Export User Data] wizard to restore your data. Otherwise you can create a new passport by using the [Enroll or Edit Fingerprints] wizard.

<Only for model with Camera>

Description of Parts

<Bottom>

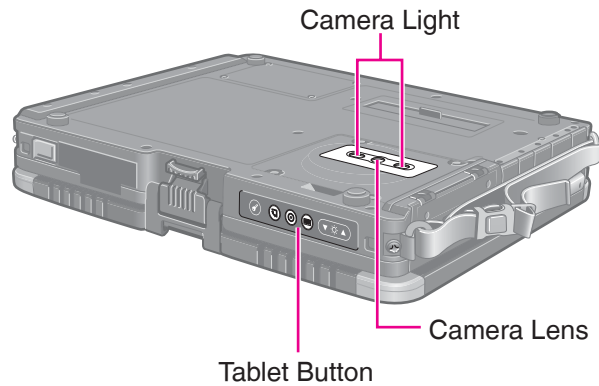

CAUTION

- Do not look directly at the camera light since it is too bright.

NOTE

- The protection seals have been put on the camera lens and camera light at the factory default setting. Remove the protection seal before using the camera.
- The RAM module cannot be upgraded.
- The “Shoulder strap” described in the *OPERATING INSTRUCTIONS* is not supplied with this computer.

■ Using the Hand Strap

The hand straps are attached on both sides of the computer respectively. To remove the hand strap, use a driver to remove the screws on each corner (A).

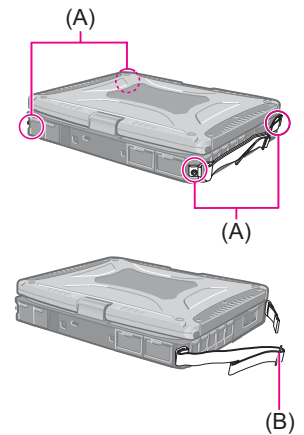

CAUTION

- Do not use the strap to carry a heavier weight than the computer. Otherwise the strap may become loose by itself.
- Do not use the strap if it becomes worn or damaged.

Remove the hand strap latch (B) to open each connector on the side of the computer.

■ Using the Camera

1 Hold the side of the computer to aim the camera.

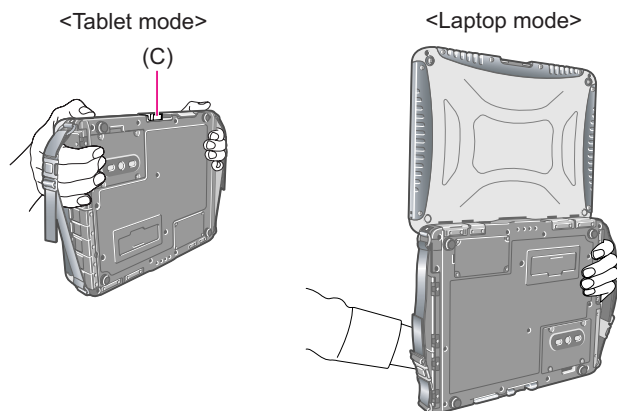

NOTE

- Make sure to close the latch (C) in Tablet mode since the camera image is displayed inverted.
- When the computer is moved from hot and humid environment to low temperature environment, dew condensation may mist up inside the lens. This is not a malfunction.
Dry the lens before use.

Starting up AMCap for TOUGHBOOK

Start up AMCap for TOUGHBOOK to take pictures and Video.

- 1 Click [start] - [All Programs] - [Panasonic] - [AMCap for TOUGHBOOK].

NOTE

- If you use this software and other multi-media software at the same time, or error may occur. Close all multi-media software including this software and restart this software.
- If an error message appears and nothing is displayed, restart this software.
- Two or more users cannot use this software with Fast User Switching function.
- When the computer has resumed from sleep or hibernation, an error may appear and connection with the camera device may be lost. If this occurs, restart this software.

Taking Pictures

Taking Pictures

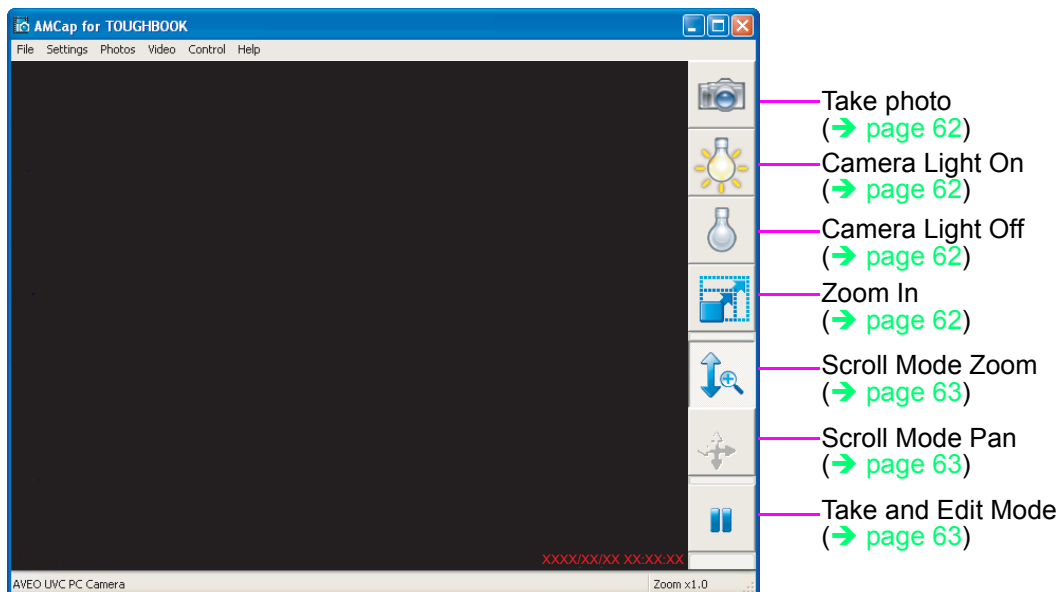

■ Take Photo

You can record the camera image as a picture.

1 Adjust the direction of camera, zoom (below), picture quality (→ [page 64](#)), etc.

2 Click  or click [Photos] - [Take photo].

- You can assign the Snap function to the Tablet Button.
(→ [page 67](#) “Assigning the Snap/Zoom In/Light Functions to the Tablet Button”)
- When you specify the destination to save and the file name for the photo you about to take, click [Photos] - [Name and Take photo]. If they are not specified, pictures are saved in the folder identified in “Changing the Settings for Taking Pictures” (→ [page 64](#)) and are assigned a temporary file name based on the date and time taken.

NOTE

- You can see taken pictures when opening this folder using Windows Explorer.
- When the distance between the camera and subject is less than 60 cm {24"}, the subject focus may be out of focus due to the limitations of the camera.

■ Camera Light On

To turn on the light of the camera.

1 Click  or click [Control] - [Camera Light] - [ON].

- You can assign the Light function to the Tablet Button.
(→ [page 67](#) “Assigning the Snap/Zoom In/Light Functions to the Tablet Button”)
- The light goes off automatically after a certain period of time. Click [Control] - [Camera Light] - [Settings] to set your preferred lighting duration.

■ Camera Light Off



To turn off the light of the camera.

1 Click  or click [Control] - [Camera Light] - [OFF].

■ Zoom In

To turn on the light of the camera.

1 Click  or click [Control] - [Zoom] and select [x 1.0], [x 1.5], [x 2.0], [x 2.5], or [x 3.0].

- You can assign the Zoom In function to the Tablet Button.
(→ [page 67](#) “Assigning the Snap/Zoom In/Light Functions to the Tablet Button”)
- Each time you click  the magnification ratio goes up in the order of [x 1.0], [x1.5], [x 2.0], [x 2.5], [x 3.0].
To return to [x 1.0], click  when the ratio is [x 3.0].

■ Scroll Mode Zoom

To enlarge or reduce the image by scrolling.

- 1** Click  or click [Control] - [Scroll Mode] - [Zoom].
- 2** Scroll upward to enlarge the image and downward to reduce.

- Trace the camera image up and down or put the mouse pointer over the image to drag up and down.
- You can change the magnification ratio between [x 1.0] and [x 3.0].

■ Scroll Mode Pan

Scroll the enlarged camera image from side to side and up and down.



- 1** Click  or click [Control] - [Scroll Mode] - [Pan].
- 2** Trace the camera image from side to side and up and down or put the mouse pointer over the image to drag from side to side and up and down to scroll.

NOTE

- You cannot use this function when the magnification ratio is less than [x 1.2].

■ Take and Edit Mode

To fix the camera image.

- 1** Click  or click [Control] - [Take and Edit Mode].
 - Click  or click [Take and Edit Mode] again to return to the actual camera image.
 - When you take a picture with the camera image fixed, the fixed image is recorded even if you change the direction of camera.
 - You can adjust the camera image using Zoom In or Pan.

Taking Still Pictures at Fixed Intervals

- 1 Click [Photos] - [Start Burst Shooting].

NOTE

- Pictures will be taken until you click [Start Burst Shooting] again.

Changing the Settings for Taking Pictures

- 1 Click [Photos] - [Settings].
- 2 Change to arbitrary settings and click [OK].

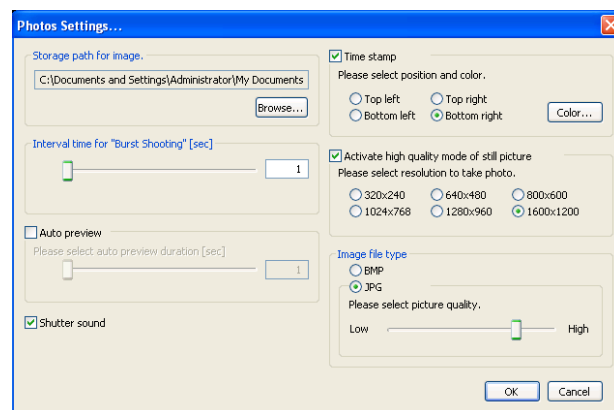

NOTE

- At [Storage path for image], if you specify the externally-connected recording device as a destination to save, software operation may become slow. In this case, specify the internal disk as the destination to save.
- High-quality pictures can be obtained by adding the check mark for [Activate high quality mode of still picture].

Shooting Video

Shooting Video

- 1 Start recording into the buffer.**
Click [Video] - [Start Recording Temporary].
- 2 Finish recording into the buffer.**
Click [Video] - [Stop Recording Temporary].
- 3 Save the buffer as a motion picture.**
 - ① Click [Video] - [Save Temporary Recorded Video].
 - ② Specify the destination to save and file name, and then click [Open].
 - “Save File Progress: XX%” is displayed. You cannot record a new Video until saving is complete. Do not close this software while it is saving.

NOTE

- You cannot use Zoom In, Pan and Time stamp functions.
- If you rotate the display, pictures are not correctly displayed. Do not rotate the display for use.
- When the distance between the camera and subject is less than 60 cm {24"}, subject may be out of focus due to limitation of the camera.
- If you specify the externally-connected recording device as a destination to save, software operation may become slow. In this case, specify the internal disk as the destination to save.

Specifying the Destination to Save the Buffer and File Size

You can specify the destination to save the buffer and file size before recording.

- 1 Click [Video] - [Temporary file name].**
- 2 Specify the destination to save and file name, and then click [Open].**
- 3 Specify the file size in [Allocate file space] to secure in the hard disk beforehand, and then click [OK].**

NOTE

- You can record over the file size specified, but jumpiness may occur for the excess of the file size during playback. Specify a sufficient area to save Motion Pictures.

Settings

■ Setting Audio

Set your preferred sound on [Audio Control] screen.

- 1 Click [Settings] - [Audio Control].

■ Setting Image Quality

Set your preferred image quality on [Image Control] screen.

- 1 Click [Settings] - [Image Control].

■ Setting Night Mode

- 1 Click [Settings] - [Image Control] - [General Setting].
- 2 Add a check mark for [Night Mode].

■ Setting the Compressed Data Format/Resolution for the Image

- 1 Click [Settings] - [Video Format].

[Color Space / Compression]

Set the compressed data format for the image.

- Setting [UYVY] is recommended for smoother display.

[Output Size]

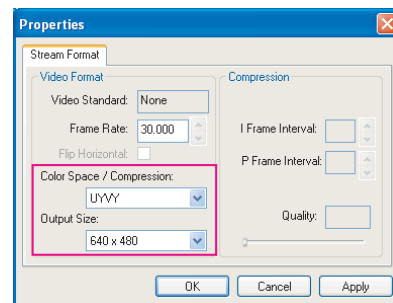

Set the image resolution.



NOTE

- If you set [Output Size], [Frame Rate] is automatically determined.

■ Assigning the Snap/Zoom In/Light Functions to the Tablet Button

You can assign the Snap/Zoom In/Light functions to the Input Panel () / Enter () / Rotation () buttons.

- 1 **Click [start] - [All Programs] - [Panasonic] - [Tablet Buttons Settings].**
<Only for model with Windows XP Professional>
<Only for model with Windows XP Tablet PC Edition>
Click [start] - [Control Panel] - [Printers and Other Hardware] - [Tablet and Pen Settings] - [Tablet Buttons].
- 2 **Click the name of the tablet button and click [Change].**
- 3 **Select [Launch an application] in [Action].**
- 4 **Input the following in [Program location].**
<When assigning the Snap function> (→ [page 62](#))
"c:\program files\panasonic\amcapt\amcapt.exe" /shutter
<When assigning the Zoom In function> (→ [page 62](#))
"c:\program files\panasonic\amcapt\amcapt.exe" /zoom_in
<When assigning the Light function> (→ [page 62](#))
"c:\program files\panasonic\lightsw\lightsw.exe"
- 5 **Click [OK] - [OK].**

NOTE

- When AMCap for TOUGHBOOK is not running, the Tablet Button to which these functions are assigned does not work.
- When you select a program by clicking [Browse], the error message, "The file path you specified does not exist. Enter a different file path." may be displayed. If this occurs, select a program again by clicking [Browse].

<only for model with internal modem>

Connecting the Internal Modem with a Telephone Jack

CAUTION

- Do not use the PBX internal phone lines installed in company offices. Doing so may lead to a fire or electric shock.
- You cannot connect the modem to the following lines.
 - Interphone
 - Intercoms
 - ISDN
- Be sure to connect the telephone cable into the modem port, not into the LAN port.
- Use a surge protector since the modem may be damaged by a sudden high voltage surge that may occur in the event of a lightning strike.

1 Open the cover and connect the telephone jack (A) to the computer by using the telephone cable (included) (B).

- Hold the cable so that the shape of the connector (C) matches the port, and insert fully until it clicks.

2 Click [start] - [Control Panel] - [Printers and Other Hardware] - [Phone and Modem Options] and change the settings as necessary.

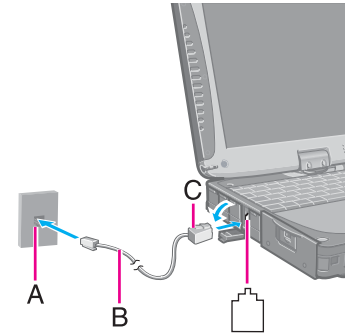

NOTE

- Do not enter standby or hibernation during communications.
- To remove the cable, press and hold the lever and pull out.

Ring Resume Function

The computer automatically resumes from standby when the telephone connected to the modem rings. You will need software to keep the computer in idle state waiting for a phone call, and if you prefer, to turn the computer to standby again afterward. For further information, refer to the instruction manual of the software application.

■ To enable this function

- 1** Click [start] - [Control Panel] - [Performance and Maintenance] - [System] - [Hardware] - [Device Manager] - [Modems], and double-click the internal modem.
- 2** Click [Power Management], add the check mark for [Allow this device to bring the computer out of standby.], and click [OK].

■ To set the time to return the computer to standby

The computer will enter standby after the set time even when the communication is not completed. You can avoid such uncompleted communication if you select [Never], but the computer does not return to standby after resuming by a phone call.

- ①** Click [start] - [Control Panel] - [Performance and Maintenance] - [Power Options] - [Power Schemes].
- ②** Set the expected communication time.

NOTE

- This function does not work when the computer is off or is in hibernation.
- Connect the AC adaptor.
- The screen remains dark after the computer resumes from standby. The previous screen display will be restored when you touch the keyboard, touch pad, touchscreen (only for model with touchscreen) or tablet buttons. Do not touch the dual touch (only for model with dual touch).
- The computer cannot resume if the telephone is not connected to the internal modem. (e.g., you cannot use a PC Card modem.)
- The computer needs some time to respond, so set the calling time longer than normal. If this is not possible on the transmission side, reduce the number of rings before answering on the software that you are using to keep the computer in idle waiting for the call.

Connecting LAN

CAUTION

- Do not connect the telephone cable to the LAN port.

1 Turn off the computer.

- Do not use standby or hibernation.

2 Open the cover and connect the cable.

Connect the LAN port (A) and the network system (server, HUB, etc.) using a LAN cable.

3 Turn on the computer.

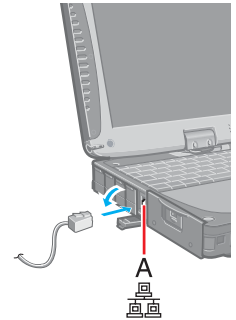

Power On by LAN/Wake Up from Wired LAN

NOTE

- Even when a password is set in the Setup Utility and [Password on boot] is set to [Enabled], entering the password is unnecessary for turning on or resuming the computer.
- Connect the AC adaptor.
- The Power On by LAN function is off under the following conditions:
 - When you turn the computer off by sliding the power switch for four seconds or longer (e.g., after a hung-up).
 - When you reattach the AC adaptor and battery pack to the computer after removing them.
- The screen remains dark after the computer resumes from standby. The previous screen display will be restored when you touch the keyboard, touch pad, touchscreen (only for model with touchscreen) or tablet buttons. Do not touch the dual touch (only for model with dual touch).

Enabling the Power On by LAN function

The computer automatically turns from off to on when the computer is accessed from the network server via the internal LAN port.

- 1 Select **[Allow]** in **[Power On by LAN]** in the **[Advanced]** menu of the Setup Utility (→ [page 89](#)).
- 2 In **[Caution]**, press **Enter**.
- 3 Press **F10**, and then select **[Yes]** and press **Enter**.
- 4 Log on to Windows as an administrator.
- 5 Click **[start]** - **[Control Panel]** - **[Performance and Maintenance]** - **[System]** - **[Hardware]** - **[Device Manager]** - **[Network adapters]** and double-click **[Intel(R) 82567LM Gigabit Network Connection]**, and then click **[Advanced]**.
- 6 Click **[Enable PME]** in **[Property]** and select **[Enabled]** in **[Value]**, and then click **[OK]**.

NOTE

- The computer may accidentally turn on if the linkage status is changed. To prevent the accidental startup, make the setting by the following steps.
 - ① Click **[start]** - **[Control Panel]** - **[Performance and Maintenance]** - **[System]** - **[Hardware]** - **[Device Manager]** - **[Network adapters]** and double-click **[Intel(R) 82567LM Gigabit Network Connection]**, and then click **[Advanced]**.
 - ② Click **[Wake on Settings]** in **[Property]** and select **[Wake on Magic Packet]** in **[Value]**, and then click **[OK]**.
 - If you forcibly shut down Windows, the Power On by LAN function will not work.
-

Enabling/Disabling the Wake Up from wired LAN function

When the Wake Up from wired LAN function is enabled, the computer automatically resumes from standby or hibernation when the computer is accessed from the network server via the internal LAN port. (Default setting)

The Wake Up from wired LAN function can be switched to enable/disable by performing the following procedure.

- 1 Click [start] - [Control Panel] - [Performance and Maintenance] - [System] - [Hardware] - [Device Manager] - [Network adapters] and double-click [Intel(R) 82567LM Gigabit Network Connection], and then click [Power Management].**
- 2 Add check marks for [Allow the computer to turn off this device to save power.] and [Allow this device to bring the computer out of standby.], and click [OK].**

We recommend you to make the above 2 settings ON/OFF simultaneously.

NOTE

- The computer may resume when another computer in the network makes unintentional access. Using the following procedure, you can prevent accidental startup by unintentional access.
 - ① Click [start] - [Control Panel] - [Performance and Maintenance] - [System] - [Hardware] - [Device Manager] - [Network adapters] and double-click [Intel(R) 82567LM Gigabit Network Connection], and then click [Power Management].
 - ② Add a check mark for [Only allow management stations to bring the computer out of standby.], and click [OK].
-

<Only for model with wireless LAN, Bluetooth and/or wireless WAN>

There are 4 ways of disabling and enabling wireless communication.

- The wireless switch on the left side of the computer (below)
- Wireless Switch Utility (→ [page 75](#))
- Settings in the [Advanced] menu of the Setup Utility (→ [page 90](#))
- Setting in the Wireless Connection Disable Utility (→ [page 76](#))

NOTE

- For further information about wireless LAN: (→ [page 78](#))
- For further information about Bluetooth: (→ [page 82](#))
- For further information about wireless WAN: Refer to the instruction manual of the wireless device.
- The wireless communication is also enabled or disabled by connecting or disconnecting the LAN cable. (→ [page 75](#))

The Wireless Switch

■ To disable all wireless communication

1 Open the cover.



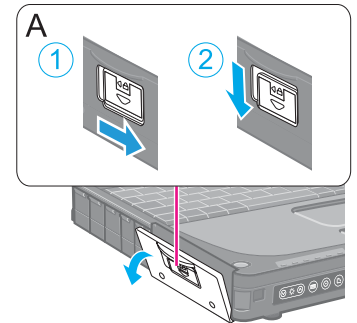

- ① Slide the latch (A) to the right to unlock the cover.
- ② Slide the latch (A) down, and open the cover.

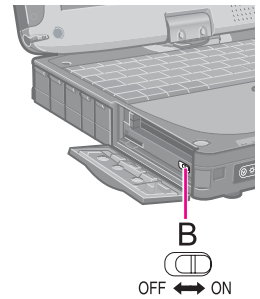

2 Slide the wireless switch (B) to OFF.



NOTE



- If you uninstall the Wireless Switch Utility, set the wireless switch to ON beforehand.
- Do not turn on/off the switch repeatedly at too short intervals.
- Do not restart, log off, or enter standby or hibernation immediately after turning on/off the switch.
- Do not turn on/off the switch while Windows is starting up.
- To use wireless communication, set the wireless device ([Wireless LAN] / [Bluetooth] / [Wireless WAN]) to [Enabled] (default) in the [Advanced] menu of the Setup Utility (→ [page 90](#)).
- When you set [Wireless Switch] to [Disabled] in the [Advanced] menu of the Setup Utility (→ [page 90](#)), the Wireless Switch Utility icon will not appear in the notification area. All wireless equipment (wireless LAN, Bluetooth, wireless WAN) will remain ready irrespective of the wireless switch setting.
- It may take some time to turn off wireless communication after switching the wireless switch off.
- If the IEEE802.11a setting is changed in [Device Manager] (→ [page 80](#)), the display will be changed accordingly.
- You can check the wireless LAN communication status in Intel® PROSet/Wireless Software. Perform either of the following procedures.
 - Double-click , , , or  on the notification area.
 - Click [start] - [All Programs] - [Intel PROSet Wireless] - [WiFi Connection Utility].

Wireless Switch Utility

This utility allows you to control the function of the wireless switch. This utility also allows you to enable or disable wireless devices from a pop-up menu in the notification area. In the default setting, all wireless devices are enabled.

■ The Wireless Switch Utility icon

The icon appears in the notification area. It shows the status of wireless devices.

-  : Indicates that the wireless devices are enabled.
-  : Indicates that the wireless devices are off.
-  : Indicates that the wireless devices have been disabled in the Setup Utility.

■ To enable or disable particular wireless devices

- 1 Click the Wireless Switch Utility icon to show the pop-up menu.
- 2 Select On or Off for the device you want to enable or disable.

■ To change the function of the wireless switch

In the default setting, the on/off settings that were selected for each device at the time you last turned off the wireless switch are restored when you set the wireless switch to ON again. You can change this function.

[Selects the device for which to turn the device status on each time with the dialog box]



Display a dialog each time you set the wireless switch to ON so you can choose which wireless device to enable.

[Turns on the following device]

Only selected devices are enabled when you set the wireless switch to ON.

[Turns on the device that was on immediately before the wireless switch was turned off the last time] (default)

When you turn on the wireless switch, the on/off settings that were selected when you last turned off the wireless switch will be restored.

- 1 Click the Wireless Switch Utility icon ( or ) on the notification area and click [Settings...].
- 2 Select the setting you want to assign to the wireless switch.
- 3 Click [OK].

Wireless Connection Disable Utility

You can automatically disable the wireless LAN/wireless WAN connection when a LAN cable is connected to your computer. You need to install the Wireless Connection Disable Utility to use this function.

Installing the utility

- 1** Log on to Windows as an administrator.
- 2** Click [start] - [Run] and input “c:\util\wdisable\setup.exe”, and click [OK].
- 3** Follow the on-screen instructions to install the Wireless Connection Disable Utility.

Checking the status of the wireless connection

NOTE

- The Wireless Switch Utility should also be installed so that the Wireless Connection Disable Utility works. The Wireless Switch Utility has already been installed at the factory.
 - To use the utility, select [Enabled] in [Wireless Switch] in the [Advanced] menu of the Setup Utility (→ [page 90](#)).
 - The utility does not automatically disable the Bluetooth connection.
-

■ Status indication

After installation, the Wireless Connection Disable Utility is automatically started after a user is logged in. An icon appears on the notification area.



: Indicates that

- the utility is enabled, and
- the wireless connection is disabled since a LAN cable is connected.



: Indicates that

- the utility is enabled, and
- the wireless connection is enabled since no LAN cable is connected.



: Indicates one of the following statuses;

- The utility does not monitor the LAN port status,
- the Wireless Switch Utility has not been started, or
- the built-in LAN device is not detected or disabled with the device manager.

■ Menu

Right-clicking the utility icon in the notification area opens a menu as follows.

Clicking the menu item causes the following utility action.

Monitoring LAN Cable: ON

Enables the Wireless Connection Disable Utility to monitor the LAN port and disable wireless connection when a LAN cable is connected.

Monitoring LAN Cable: OFF

Disables the Wireless Connection Disable Utility, and enables wireless connection regardless of whether a LAN cable is connected or not.

Exit

Exits the Wireless Connection Disable Utility and enables wireless connection.

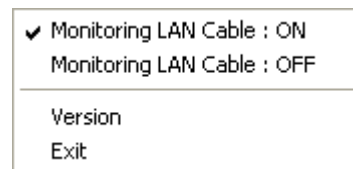

<Only for model with wireless LAN>

CAUTION

- **Do not use wireless LAN on airplanes, in hospitals, or in other locations where wireless LAN signals may affect peripheral devices.**
Follow the instructions of airline companies and hospitals. If you use the computer in these locations, turn off the wireless LAN.
- **To avoid unauthorized access to the computer through wireless LAN**
We recommend you to make security settings such as encryption before using wireless LAN. Otherwise the hard disk data such as the shared files can be exposed to the risk of unauthorized access.

NOTE

- Communication is established through the wireless LAN antenna (A). Do not block the antenna area with your hand or body.
- You cannot use the wireless LAN function together with the Fast User Switching function.
- The transmission rate will be lower when a microwave oven is used near by.
- To use wireless LAN, set [Wireless LAN] to [Enabled] (default) in the [Advanced] menu of the Setup Utility (→ [page 90](#)).
- Wireless communication may momentarily be interrupted when you use the display rotation function in the Tablet mode.

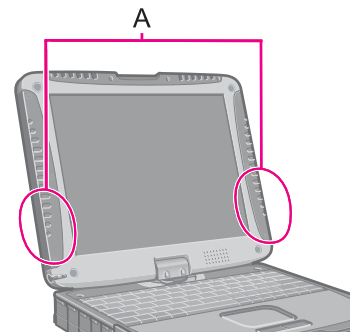

■ To turn on/off wireless LAN

Disabling/Enabling Wireless Communication (→ [page 73](#))

■ To check the wireless LAN communication status

Status indication (→ [page 77](#))

Setting the Profiles

1 Double-click  /  /  on the notification area.

The [Intel® PROSet/Wireless] screen appears.

- When  or  is displayed, skip step 2.

2 When you double-clicked  in step 1, slide the wireless switch to turn on.

3 Click [Profiles...] at the lower right corner of the window, and click [Add...].

4 Enter the profile name and wireless network name (SSID), and make other necessary changes, then click [Next].

5 Make necessary settings and click [OK].

6 Select the profile you set and click [Connect].

7 Click [Close].



NOTE

- You need to set the profile for each user.
- The settings depend on the network environment. For further information, ask the system administrator or the person in charge of the network.
- For further information of Intel® PROSet/Wireless Software, refer to [Help] in the menu bar.

Enabling/Disabling the Wireless LAN Standard IEEE802.11a (802.11a)

- 1 Click  or  on the notification area.
- 2 Click [802.11a Disabled] or [802.11a Enabled].

NOTE

- In some countries, communication using IEEE802.11a (5 GHz wireless LAN) standard is restricted by law.
- The Wireless Switch Utility icon ( or ) indicates the on/off status of wireless LAN and/or Bluetooth and/or wireless WAN, not the setting of IEEE802.11a.
- If IEEE802.11a is enabled or disabled while the computer is connected to an IEEE802.11b/g access point, the connection will be temporarily interrupted.
- You can also change the IEEE802.11a setting in [Device Manager].
 - ① Click [start] - [Control Panel] - [Performance and Maintenance] - [System] - [Hardware] - [Device Manager].
 - ② Double-click [Network adapters] and double-click [Intel(R) WiFi Link 5100 AGN].
 - ③ Click [Advanced], and then click [Wireless Mode] in [Property].
 - ④ Remove the check mark from [Use default value] in [Value], and select the settings (e.g., [802.11a and 802.11g]).
 - ⑤ Click [OK].

If you turn on/off 802.11a using the popup menu of Wireless Switch Utility, the setting in [Device Manager] will be accordingly changed as below.

Settings in Device Manager	Settings in Wireless Switch Utility	
	When 802.11a is enabled	When 802.11a is disabled
[802.11a, 802.11b and 802.11g] [802.11b and 802.11g]	a+b+g is enabled	b+g is enabled
[802.11g only] [802.11a and 802.11g]	a+g is enabled	g is enabled
[802.11a only] [802.11b only]	a is enabled	b is enabled

Wake Up from Wireless LAN

Enabling the Wake Up from Wireless LAN function

The computer automatically resumes from standby or hibernation when the computer is accessed from the network server via the wireless LAN.

- 1** Click [start] - [Control Panel] - [Performance and Maintenance] - [System] - [Hardware] - [Device Manager] - [Network adapters] and double-click [Intel(R) WiFi Link 5100 AGN], and then click [Power Management].
- 2** Add check marks for [Allow the computer to turn off this device to save power.] and [Allow this device to bring the computer out of standby.], and click [OK].

CAUTION

- Even if the Wake Up from wireless LAN function is enabled, it will be disabled once the communication stops for even a moment (for example, when there is heavy signal traffic or the computer is taken out of the communication range of the access point).
The Wake Up from wireless LAN function will also be disabled if the wireless switch (→ [page 73](#)) at the ON position is set to OFF.
- While the Wake Up from wireless LAN function is enabled, the wireless ready LED indicator lights in standby or hibernation mode. This does not necessarily mean that the wireless connection is established.

NOTE

- The computer may resume when another computer in the network makes unintentional access.
Using the following procedure, you can prevent accidental startup by unintentional access.
 - ① Click [start] - [Control Panel] - [Performance and Maintenance] - [System] - [Hardware] - [Device Manager] - [Network adapters] and double-click [Intel(R) WiFi Link 5100 AGN], and then click [Power Management].
 - ② Add a check mark for [Only allow management stations to bring the computer out of standby.], and click [OK].
- If the wireless switch is set to ON, and the Wake Up from wireless LAN function is enabled, the computer consumes electricity, even in the standby/hibernation mode.
- The Wake Up from wireless LAN function does not work when network connection is established in ad hoc mode.
- The Wake Up from wireless LAN function does not work when IEEE802.11n is selected.

<Only for model with Bluetooth>

You can access internet and other Bluetooth devices without connecting cables.

NOTE

- Communication is established through the Bluetooth antenna (A). Do not block the antenna area with your hand or body.
- To use Bluetooth, set [Bluetooth] to [Enabled] (default) in the [Advanced] menu of the Setup Utility (→ [page 90](#)).
- The transmission rate will be lower when a microwave oven is used near by.
- When you uninstall the Bluetooth Driver, turn Bluetooth off.

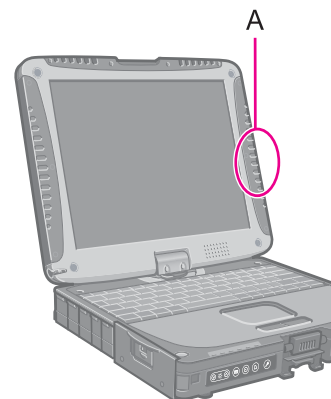

Using the Bluetooth Function

Before using a Bluetooth, turn the Bluetooth communication on.

Turning on/off the Bluetooth communication

- 1 Slide the wireless switch to turn ON / OFF Bluetooth (→ [page 73](#)).

To check the Bluetooth communication status

- 1 Place the cursor over the Wireless Switch Utility icon ( or ) on the notification area.
A tooltip appears.

■ To access the online manual

- ① Click [start] - [All Programs] - [Bluetooth] - [User's Guide].

Inserting/Removing the Hard Disk Drive

To change your hard disk drive, contact Panasonic Technical Support.

CAUTION

- Back up all the important data before removing the hard disk drive.
- If you need to read the hard disk data on another computer for repair or any other purpose, set [Hard Disk Lock] to [Disabled] in the [Security] menu of the Setup Utility (→ [page 92](#)) before removing the hard disk drive.
- Carefully remove/insert the hard disk drive since the hard disk drive is extremely sensitive to shock. Note that static electricity may affect some internal components.

1 Turn off the computer and disconnect the AC adaptor.

- Do not use standby or hibernation.

2 Remove the battery pack (→ [page 29](#)).

3 Insert/Remove the hard disk drive.

- To remove

- ① Slide the latch (A) to the right to unlock the cover.
- ② Slide the latch (A) down, and open the cover.

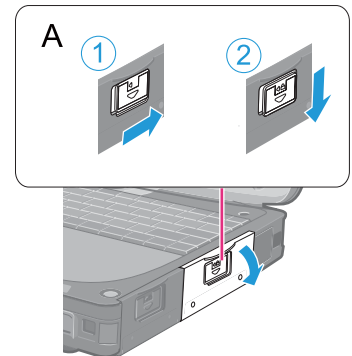

- ③ Pull the tab (B) of the hard disk drive and slide it out of the slot.

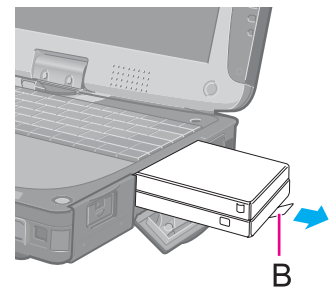

- To insert
- ① Insert the hard disk drive until it surely fits in the slot.

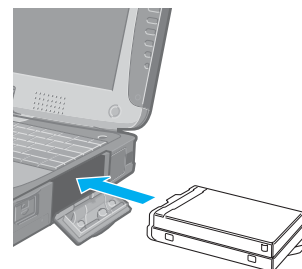

- ② Close the cover until it clicks, and slide the latch (C) to the left to lock the cover.

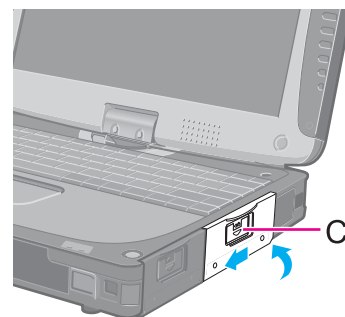

4 Insert the battery pack (→ [page 29](#)).

CAUTION

- Confirm that the latch is surely locked so that it does not fall when you carry the computer.

NOTE

- You can erase the data before changing the hard disk drive. (→ [page 101](#))
- You can check that the hard disk is recognized or not in the [Information] menu of the Setup Utility (→ [page 86](#)). If the hard disk is not recognized, turn off the computer and insert it again.

You can make the settings of the computer's operating environment (password settings, startup drive selection, etc.)

Starting the Setup Utility

- 1 Turn on or restart the computer.
- 2 Press **F2** or **Del** while [Panasonic] boot screen is displayed soon after the computer starts the startup procedure.

When [Enter Password] is displayed, enter your password.

When you start the Setup Utility with Supervisor Password

- You can make the settings of all items of the Setup Utility.

When you start the Setup Utility with User Password

- Note the following:
 - In the [Advanced] and [Boot] menus, you cannot make the settings of all items.
 - In the [Security] menu, you can change only the User Password when [User Password Protection] is set to [No Protection]. You cannot delete the User Password.
 - In the [Exit] menu, you cannot make the setting of [Load Default Values] and [Boot Override].
 - **F9** (Setup Defaults) does not function.

Information Menu

Underlined items are the factory presets.

Language	<u>English</u> Japanese
----------	----------------------------

Product Information

Model No. Serial No.	Computer information (cannot be changed.)
-------------------------	--

System Information

Processor Type Processor Speed Memory Size Available Memory Hard Disk Optical Drive	Computer information (cannot be changed.)
--	--

BIOS Information

BIOS Embedded Controller Accumulative Operating Time Access Level	Computer information (cannot be changed.)
--	--

Main Menu

Underlined items are the factory presets.

System Date <ul style="list-style-type: none"> Day of the Week/Month/Day/Year. You can use <u>Tab</u> to move the cursor. 	[xxx xx/xx/xxxx]
System Time <ul style="list-style-type: none"> 24-hr. style. You can use <u>Tab</u> to move the cursor. 	[xx:xx:xx]

Main Configuration

Touch Pad	Disabled <u>Enabled</u>
Touchscreen Mode <ul style="list-style-type: none"> Only for model with touchscreen 	Touchscreen Mode Tablet Mode <u>Auto</u>
Display <ul style="list-style-type: none"> The display during the Windows start-up process. When an external display is not connected, the information appears on the internal LCD even though the [External Monitor] is selected. 	<u>External Monitor</u> Internal LCD
Battery Charging Indicator	On Continuous Flashing
Power on AC	Disabled Enabled
LID Switch	Disabled <u>Enabled</u>

Environment	Normal Temperature High Temperature <u>Auto</u>
Current Status <ul style="list-style-type: none"> • Only when [Environment] is set to [Auto]. 	Depending on the battery status, either “Normal Temperature” or “High Temperature” is displayed.
▶ Concealed Mode Configuration	Enter the sub-menu. ^{*1}

*1 The submenu that appears when [Concealed Mode Configuration] is selected:

Concealed Mode	<u>Disabled</u> Enabled
LCD Backlight <ul style="list-style-type: none"> • Can be changed only when [Concealed Mode] is set to [Enabled]. 	<u>ON</u> Minimum OFF
LED <ul style="list-style-type: none"> • Can be changed only when [Concealed Mode] is set to [Enabled]. • Except for the SD Memory Card indicator and LED of external devices. 	<u>ON</u> OFF
Sound <ul style="list-style-type: none"> • Can be changed only when [Concealed Mode] is set to [Enabled]. 	<u>ON</u> OFF
Wireless Radio <ul style="list-style-type: none"> • Can be changed only when [Concealed Mode] is set to [Enabled]. 	<u>ON</u> OFF
Camera Light <ul style="list-style-type: none"> • Only for model with Camera • Can be changed only when [Concealed Mode] is set to [Enabled]. 	<u>ON</u> OFF
Backlit Keyboard <ul style="list-style-type: none"> • Only for model with Backlit Keyboard • Can be changed only when [Concealed Mode] is set to [Enabled]. 	<u>ON</u> OFF

Advanced Menu

CPU Configuration

Underlined items are the factory presets.

Execute-Disable Bit Capability • [Enabled] indicates that this computer supports hardware-based Data Execution Prevention (DEP).	Disabled <u>Enabled</u>
Core Multi-Processing	Disabled <u>Enabled</u>
Intel (R) Virtualization Technology	<u>Disabled</u> Enabled
Intel (R) Trusted Execution Technology	<u>Disabled</u> Enabled

Peripheral Configuration

▶ Serial Port Settings • Used to configure the serial port A/B and GPS.	Enter the sub-menu ^{*2} .
LAN	Disabled <u>Enabled</u>
Power On by LAN • Can be changed only when [LAN] is set to [Enabled]. • To use [Power On by LAN], make additional settings in [Device Manager] (→ page 71).	<u>Deny</u> Allow

*2 The submenu that appears when [Serial Port Settings] is selected:

Serial Port A	Disabled Enabled <u>Auto</u>
I/O IRQ • Can be changed only when [Serial Port A] is set to [Enabled].	<u>3F8/IRQ4</u> 2F8/IRQ3 3E8/IRQ7 2E8/IRQ5
Serial Port B	Disabled Enabled <u>Auto</u>
I/O IRQ • Can be changed only when [Serial Port B] is set to [Enabled].	3F8/IRQ4 <u>2F8/IRQ3</u> 3E8/IRQ7 2E8/IRQ5

GPS <ul style="list-style-type: none"> • Only for model with GPS 	Disabled Enabled <u>Auto</u>
I/O IRQ <ul style="list-style-type: none"> • Can be changed only when [Serial Port A] is set to [Enabled]. • Can be changed only when [GPS] is set to [Enabled]. 	3F8/IRQ4 2F8/IRQ3 <u>3E8/IRQ7</u> 2E8/IRQ5

Wireless Switch	Disabled <u>Enabled</u>
Wireless LAN <ul style="list-style-type: none"> • Only for model with wireless LAN 	Disabled <u>Enabled</u>
Wireless WAN <ul style="list-style-type: none"> • Only for model with wireless WAN 	Disabled <u>Enabled</u>
Bluetooth <ul style="list-style-type: none"> • Only for model with Bluetooth 	Disabled <u>Enabled</u>
Modem <ul style="list-style-type: none"> • Only for model with internal modem 	Disabled <u>Enabled</u>
ExpressCard Slot <ul style="list-style-type: none"> • Only for model with ExpressCard slot 	Disabled <u>Enabled</u>
PC Card Slot	Disabled <u>Enabled</u>
SD Slot	Disabled <u>Enabled</u>
IEEE1394 Port	Disabled <u>Enabled</u>
Smart Card <ul style="list-style-type: none"> • Only for model with Smart Card slot 	Disabled <u>Enabled</u>
USB Port	Disabled <u>Enabled</u>
Port Replicator USB Port <ul style="list-style-type: none"> • If [Port Replicator USB Port] is set to [Disabled], the LAN port of port replicator or the car mounter is also disabled. 	Disabled <u>Enabled</u>
Legacy USB Support	Disabled <u>Enabled</u>

Boot Menu

Boot Option Priorities

Boot Option #1	USB Floppy Disk* ³
Boot Option #2	Hard Disk
Boot Option #3	USB CD/DVD Drive
Boot Option #4	LAN
Boot Option #5	USB Hard Disk

■ To change the boot order

The default order is [USB Floppy Disk*³] -> [Hard Disk] -> [USB CD/DVD Drive] -> [LAN] -> [USB Hard Disk].

- Press **Enter** on the boot device you want to change and select the boot device from the following menu.
 - When a selected boot device in the following menu already exists in either of the [Boot Option (#1 to #6)], the boot device appears at the newly selected position by switching the positions with the original boot device that existed before at the position.
 - When you select [Disabled] in the following menu, the disabled [Boot Option] is ignored and the boot device in the next [Boot Option] operates.

Hard Disk
LAN
USB Floppy Disk* ³
USB Hard Disk
USB CD/DVD Drive
Disabled

*³ Use the Panasonic USB floppy disk drive (optional: CF-VFDU03U)

Security Menu

Boot Prompt Configuration

Underlined items are the factory presets.

Setup Utility Prompt <ul style="list-style-type: none"> When [Setup Utility Prompt] is set to [Disabled], the message “Press F2 for Setup / F12 for LAN” is not displayed on [Panasonic] boot screen. However, F2 and F12 will work even if the message is not displayed. 	Disabled <u>Enabled</u>
Password on boot	Disabled <u>Enabled</u>
Set Supervisor Password	Enter the sub-menu.
Hard Disk Lock <ul style="list-style-type: none"> Can be changed only when [Set Supervisor Password] is set. 	<u>Disabled</u> Enabled
User Password Protection	Protected <u>No Protection</u>
Set User Password <ul style="list-style-type: none"> Can be changed only when [Set Supervisor Password] is set. 	Enter the sub-menu.
▶ Embedded Security(TPM) <ul style="list-style-type: none"> Only for model that supports TPM For information on TPM, refer to the <i>Installation Manual</i> of “Trusted Platform Module (TPM)”. Click [start] - [Run], enter “c:\util\drivers\tpm\readme.pdf”, and click [OK]. 	Enter the sub-menu.
▶ Fingerprint Security <ul style="list-style-type: none"> Only for model with Fingerprint Reader 	Enter the sub-menu.
▶ AMT Configuration	Enter the sub-menu.

Exit Menu

Save Values and Reboot	To reboot the system after saving the changes.
Reboot Without Saving Changes	To reboot the system without saving the changes.

Save Options

Save Current Values	To save the changes for all Setup options.
Load Previous Values	To load previous values for all Setup options.
Load Default Values	To return the settings to the default values.

Boot Override

(Device Information)	To select a boot device which operates only in the next booting.
▶ Diagnostic Utility	Execute Diagnostic Utility.

Enlarging the screen items

You can enlarge the screen items such as characters, icons, title bars and cursor.

CAUTION

- “Icon Enlarger” will not start up if the display resolution is set lower than 1024 x 768 dots.

NOTE

- A part of the enlarged menu or some screen items may be hidden. In this case, overlay the cursor to display pop-ups, scroll the screen, or use other functions to display the hidden items.
- The Icon Enlarger setting affects the website characters displayed by Internet Explorer and the e-mail characters in Outlook Express. Some characters of website and e-mail may not be enlarged.

Preparation

Close all of the applications before using “Icon Enlarger”.

- 1** Click [start] - [All Programs] - [Panasonic] - [Icon Enlarger].
- 2** Select the size.
- 3** Click [OK].

The screen will be displayed in the selected size.

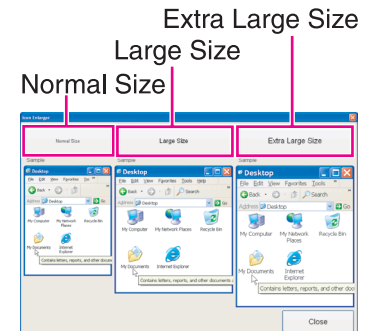



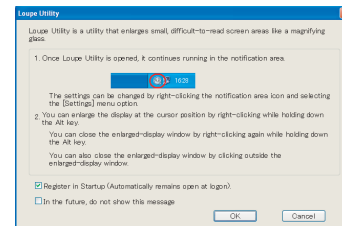

You can magnify the specific part of the screen.

Activating the Loupe Utility

- 1 Click [start] - [All Programs] - [Panasonic] - [Loupe Utility].
- 2 Click [OK].
 -  appears on the notification area.



Using the Loupe Utility

- 1 Point the cursor  at the part of the screen you want to magnify.
- 2 Press and hold **Alt**, and right-click.
 - The part pointed by the cursor is magnified.
 - Alternatively you can double-click , or right-click  and click [Show Loupe].
- 3 Drag the loupe window (A) to move the magnified part.
 - To hide the loupe window, click the Hide button  (B).
 - Alternatively you can click any part out of the loupe window, or press and hold **Alt** and right-click.
 - To change the loupe window size, drag the bottom-right corner (C).
The size range you can enlarge/shrink depends on the screen's resolution.

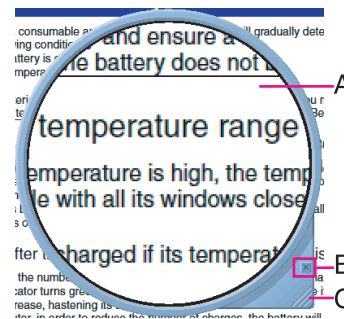

NOTE

- The magnified text or image in the loupe window is fixed at the moment that the part is magnified (e.g., at the moment you press and hold **Alt** and right-click). To reflect the change you made on the original screen to the loupe window, click the loupe window.
- The Loupe Utility does not work with some applications.

Setting the Loupe Utility

1 Right-click  on the notification area.



2 Click [Settings].

[Show/hide shortcuts assignment]

- When using the external mouse/touch pad

- ① Click [Mouse/Touch pad]
- ② Click a combination of **Alt**, **Ctrl**, and **Shift**, and add the check mark. (Multiple keys can be combined; for example, **Ctrl + Alt**)
- ③ Select either [Right click] or [Left Click] to use in combination with the key(s) selected in ② above.

- When using the keyboard

- ① Click [Keyboard].
- ② Click the text box and then press the key used for the shortcut. (e.g., **Alt + Z**, **Ctrl + Alt + Z**, etc.)

[Window shape]

Select the shape of the loupe window.

[Autorun]

Add a check mark to run the Loupe Utility when Windows starts up.

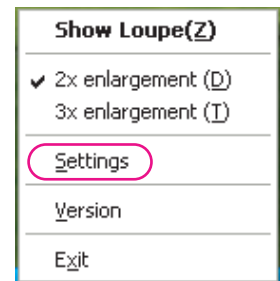

3 Click [OK].

If it appears that the hardware installed in this computer is not operating properly, you can use the PC-Diagnostic Utility to determine whether or not there is a problem.

If the utility discovers a problem in the hardware, contact Panasonic Technical Support.

Software cannot be checked using this utility.

Hardware that can be checked using the PC-Diagnostic Utility

- CPU/Systems (check CPU)
- RAM XXX MB (check Memory)
- HDD XXX GB (check Hard Disk)
- Video (check Video Controller)
- Sound^{*1}
- Modem^{*2}
- LAN
- Wireless LAN^{*3}
- Bluetooth^{*4}
- GPS^{*5}
- USB
- IEEE 1394
- PC Card (check PC Card Controller)
- SD (check SD Card Controller)
- Express Card^{*6}
- Smart Card^{*7}
- Serial Port
- Keyboard
- Touch Pad
- Touchscreen^{*8}

*1 When the PC-Diagnostics Utility is running a loud beep will sound, so do not use headphones as this time. (The beep will not sound if mute is using Windows or [Sound] is turned off in [Concealed Mode Configuration].)

*2 Only for model with internal modem

*3 Only for model with wireless LAN

*4 Only for model with Bluetooth. When the wireless switch is not set to ON, it does not work.

*5 Only for model with GPS

*6 Only for model with ExpressCard slot

*7 Only for model with Smart Card slot

*8 Only for model with touchscreen (The display icon is displayed as “Touch Screen” for the model with Dual Touch as well.)

- When the video diagnostic check is running, the display may be distorted, and when the audio diagnostic check is running, sounds may be generated from the speaker. These are not malfunctions.

Regarding the PC-Diagnostic Utility

NOTE

- For the hard disk and memory only, you can select standard diagnostic check or extended diagnostic check. When the PC-Diagnostic Utility starts up, it will run the standard diagnostic check.
- We recommend that you use the touch pad for operations. When not using the touch pad, you can operate using the internal keyboard instead. Do not use the touchscreen or the dual touch.

Operations	Touch pad operations	Internal keyboard operations
Select icon	Place the cursor above the icon	Press Space , and then press → ← ↑ ↓ (☒ (close) cannot be selected)
Click the icon	Tap or click (right click cannot be used)	Press Space above the icon
Complete the PC-Diagnostics Utility and then restart the computer	Click ☒ (close)	Press Ctrl + Alt + Del

- If the touch pad does not operate properly, press **Ctrl** + **Alt** + **Del** to restart the computer, or press the power switch to turn the power off, and then restart the PC-Diagnostic Utility.

Running the Diagnostic Check

Run this utility using the default settings in the Setup Utility.

If the Setup Utility or other settings will not allow hardware to be executed, the hardware icon will be displayed in gray. You can also start the Diagnostic Check from [Diagnostic Utility] on the [Exit] menu of Setup Utility besides the following method (→ [page 93](#)).





- 1 Connect the AC adaptor, and turn on the wireless switch (→ [page 73](#)).**
During the diagnostic check, do not remove the AC adaptor, or attach any peripheral devices.
- 2 Turn on or restart the computer, and press **F2** or **Del** while [Panasonic] boot screen is displayed.**
The Setup Utility starts up.
 - If the password is requested, enter the Supervisor Password.
 - If you are using the computer after changing the settings from the status at the time of purchase, we recommend that you make a note of the settings that are changed.
- 3 Press **F9**.**
At the confirmation message, select [Yes] and press **Enter**.

4 Press **F10**.

At the confirmation message, select [Yes] and press **Enter**.
The computer will restart.

5 While [Panasonic] boot screen is displayed, press and hold **Ctrl + F7** until “Please Wait” appears at the bottom of the display.

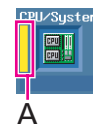

When the PC-Diagnostic Utility starts up, it will automatically begin the diagnostic check for all hardware components.

- If the password is requested, enter the password.
- The touch pad and the internal keyboard may not be used when each hardware checking is running. While checking, blue and yellow colors are displayed on the left side of the hardware icon (A).
- By clicking the icon, you can execute the following operations:
 -  : Start the diagnostic check from the beginning
 -  : Stop the diagnostic check (You cannot restart the check partway through by clicking )
 -  : Display help (click the screen or press **Space** to return to the original diagnostic check screen)
- You can check the status of the diagnostic check by the display color on the left side of the hardware icon (A).
 - Aqua: Not running diagnostic check
 - Alternating blue and yellow: Currently running diagnostic check. The interval of the alternating colors differs depending on the type of diagnostic check currently running.
During memory diagnostic check, the display may freeze for a long period of time. Wait until the process is complete.
 - Green: No problems discovered
 - Red: Problems discovered



NOTE

- Using the following procedure, you can run a diagnostic check on a specified hardware component, or run an extended diagnostic check on the memory or the hard disk (The extended diagnostic check is only for the memory and the hard disk). The extended diagnostic check is more detailed, and so requires a longer period of time to run.

- ① Click  to stop the diagnostic check.
- ② Click the icon for the hardware that is not to be checked, so that the icon is displayed in gray (B). When running a check on the memory or the hard disk, clicking the icon once will turn on the extended diagnostic check (“FULL” (C) will be displayed below the icon); click again, and the icon will be displayed in gray (D).
- ③ Click  to start the diagnostic check.



B

e.g. hard disk

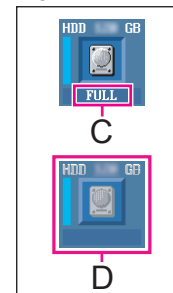

D

6 When all the hardware has been checked, confirm the diagnostic check results.

If the display is red and the message “Check Result TEST FAILED” is displayed, you can assume that there is a problem with the computer’s hardware. Confirm which hardware component is displayed as red, and contact Panasonic Technical Support.

If the display is green and the message “Check Result TEST PASSED” is displayed, the computer’s hardware is operating normally. Continue using the computer as it is. If the computer still does not operate properly, reinstall the software (⇒ *OPERATING INSTRUCTIONS* “Reinstalling Software”).

NOTE

- If you run a memory diagnostic check after installing a new RAM module (sold separately) and the message “Check Result TEST FAILED” is displayed:
Remove the additional RAM module and run the diagnostic check again. If the message “Check Result TEST FAILED” is still displayed, you can assume that there is a problem with the internal RAM module.

7 After the diagnostic check is complete, click (close), or press **Ctrl + Alt + Del** to restart the computer.

When disposing the computer or transferring the ownership, erase all hard disk data in order to avoid data leakage. Even if you erase the data or initialize the hard disk using normal Windows commands, the data can be read with some special software. Use the hard disk data erase utility to erase the data completely.

Note that transferring of the ownership without uninstalling the commercial software will be a violation of the software's license agreement.

The hard disk data erase utility erases data using an overwriting method, but there is a possibility that due to malfunctions or other operational errors, data may not be completely erased. There are also specialized devices that may be able to read data that has been erased using this method. If you need to erase highly confidential data, we recommend that you contact a company that specializes in this process. Panasonic Corporation will bear no responsibility for losses or damages suffered as a result of the use of this utility.

NOTE

- This utility cannot erase data for specific partitions.

Preparation

- Prepare the following items:
 - The Product Recovery DVD-ROM for Windows XP (included)
 - Panasonic CD/DVD drive (optional) (refer to recent catalogs and other sources for information about the products available)
- Remove all peripherals (except for the CD/DVD drive).
- Connect the AC adaptor and do not remove it until hard disk data erase is complete.

1 Turn off the computer and connect the CD/DVD drive to the USB port.

2 Turn on the computer, and press F2 or Del while [Panasonic] boot screen is displayed.

The Setup Utility starts up.

- If the password is requested, enter the Supervisor Password.

3 Press F9.

At the confirmation message, select [Yes] and press Enter.

4 Press F10.

At the confirmation message, select [Yes] and press Enter.

The computer will restart.

5 Press F2 or Del while [Panasonic] boot screen is displayed.

The Setup Utility starts up.

- If the password is requested, enter the Supervisor Password.

6 Set the Product Recovery DVD-ROM for Windows XP into the CD/DVD drive.

- 7** Select the [Exit] menu, then select your CD/DVD drive in [Boot Override].
- 8** Press Enter.

The computer restarts.

 - If [Enter Password] is displayed during the following procedures, input the Supervisor Password or the User Password.
- 9** Press 2 to execute [2. [Erase HDD]].
 - To cancel this operation, press 0.
- 10** At the confirmation message, press Y.
- 11** When [<<< Start menu >>>] is displayed, press Enter.

The approximate time required for erasing data will be displayed.
- 12** Press Space.

At the confirmation message, press Enter.
The hard disk erase process starts. When the operation is completed, the [Hard disk data has been deleted] message will appear. If a problem has occurred during the operation, an error message will appear.

 - To cancel partway, press Ctrl + C. The data erasure will be up to that point.
- 13** Remove the Product Recovery DVD-ROM, and then press any key to turn off the computer.

Network Connections and Communications Software

Close the communications software before using the power saving function.

- If the power saving function (standby or hibernation) is activated while communications software is used, the network connection may be interrupted, or the performance may be adversely affected. In this case, restart the computer.
- In a network environment, set the [System standby] and [System hibernates] settings to [Never].
Click [start] - [Control Panel] - [Performance and Maintenance] - [Power Options] - [Power Schemes].

Computrace[®] software

Computrace[®] software tracks your stolen computer.

- Computrace[®] software is not included in this computer.
- Refer to the following URL for Computrace[®] software for installation and available service regions. Note that this service is only available in certain regions.
<http://www.absolute.com>

NOTE

- Consult Absolute Software Corp. before disposal.

Regarding Windows XP

You can select the Classic view of Control Panel or the Classic Start menu. You can also change the way a user logs on or off. This manual explains using the Windows XP default setting (not Classic view or Classic Start menu etc.).

- Windows Update
You can update to the latest patches and service packs for Windows with the following menus.
Click [start] - [All Programs] - [Windows Update].
Do not apply "Driver Updates" even if a message to update a driver appears. If a driver update is required, contact your technical support office.
- If the message "Your computer might be at risk" is displayed
Select  (red icon) on the notification area and make the appropriate settings. The Windows Security Center regularly gives you notice so that you can make the optimum settings. This is not an error message and you can use the computer. However, making appropriate measures is recommended to reduce the risk of virus and other attacks.

Using the Windows Associated Files

The Windows files included in the Windows XP DVD-ROM for OS are contained in the following folders:

<Only for model with Windows XP Professional>

c:\windows\docs, c:\windows\dotnetfx, c:\windows\i386, c:\windows\support, c:\windows\valueadd

<Only for model with Windows XP Tablet PC Edition>

c:\windows\docs, c:\windows\dotnetfx, c:\windows\i386, c:\windows\support, c:\windows\valueadd, c:\windows\cmpnents

Serial Devices

The COM ports of the computer are assigned as below.

- COM1 : Serial Port A
- COM2 : Serial Port B (Port replicator^{*1}/Car mounter^{*1})
- COM3 : GPS^{*1}

^{*1} Optional

If you change the assignment, the serial devices may not work properly.

Follow the instructions below when an error message appears. If the problem persists or if the error message is not shown here, contact Panasonic Technical Support.

Error Message	Solution
Bad System CMOS	An error has occurred in the memory of system settings. This occurs when the memory content is changed by an unexpected program operation, etc. <ul style="list-style-type: none">● Start the Setup Utility and return the settings to the default values, and then change the settings as necessary.● If the problem persists, the internal clock battery may need to be replaced. Contact Panasonic Technical Support.
System CMOS Checksum Error	
Invalid Year. System date restored to 01/01/2008	The date and time settings are not correct. <ul style="list-style-type: none">● Start the Setup Utility and set the correct date and time.● If the problem persists, the internal clock battery may need to be replaced. Contact Panasonic Technical Support.
Press <F2> to enter setup	<ul style="list-style-type: none">● Write down the error details and press F2 or Del to start the Setup Utility. Change the settings if necessary.
RAM Module Failed	When the RAM module is not inserted correctly or the RAM module is not conforming to the computer's specifications, a beep will sound and the "RAM Module Failed" message will be displayed when you turn the power on. <ul style="list-style-type: none">● Press the power switch for 4 seconds or longer to turn off the computer, confirm that the RAM module conforms to the specifications, and reinsert it.

Refer to the following instructions when a problem occurs. If the remedies indicated in the chart do not solve the problem, contact Panasonic Technical Support. For a software problem, refer to the instruction manual of the software.

- To check the computer's usage status (→ [page 117](#)).

■ Shut Down

Cannot shut down or restart Windows.	<ul style="list-style-type: none">● Remove USB devices.● It may take 1 or 2 minutes to shut down.
--------------------------------------	--

■ Standby or Hibernation

Cannot enter standby or hibernation.	<ul style="list-style-type: none">● Remove USB devices temporarily. If the problem persists, restart the computer.● It may take 1 or 2 minutes to enter standby or hibernation.● The computer may not enter standby when the computer is communicating via modem.● The computer does not enter standby or hibernation immediately after resuming. Wait approximately one minute.
Cannot enter standby or hibernation automatically.	<ul style="list-style-type: none">● Disconnect peripheral devices.
The computer does not resume.	<ul style="list-style-type: none">● If you slide and hold the power switch for four seconds or longer, the power will be turned off forcibly and the computer will not resume. In this case, all unsaved data will be lost.● You disconnected the AC adaptor and the battery pack while the computer was in standby mode. If the computer's power supply is disconnected in standby mode, unsaved data will be lost and the computer will not resume.● The battery is exhausted. Standby and hibernation consume some power.
The computer will not automatically enter standby/hibernation mode.	<ul style="list-style-type: none">● If you connect to a network using wireless LAN function, select the profile and connect to the access point (→ page 79).● If you do not use wireless LAN function, turn off wireless LAN function (→ page 73).● Make sure that you are not using any software that regularly accesses the hard disk.● Close AMcap for TOUGHBOOK.



■ Sound

No sound.	<ul style="list-style-type: none">● Press Fn+F4 or Fn+F6 to cancel mute.● Press Fn+F8 to turn off the concealed mode.● Restart the computer.
Distorted sound.	<ul style="list-style-type: none">● Performing Fn key combinations sometimes causes sound distortion. Stop and restart playback.

■ Sound

Cannot change the volume by pressing Fn+F5 or Fn+F6 .	<ul style="list-style-type: none"> ● Activate the Windows sound function. When it is not active, the volume does not change even if  is displayed.
“There was an error updating the registry” appears when Sound Recorder is started.	<ul style="list-style-type: none"> ● Sound Recorder is started by a limited account user whose language setting is not the same as the administrator user who last started Sound Recorder. This does not affect the operation.

■ Keyboard

Only numbers can be input.	<ul style="list-style-type: none"> ● When the indicator  is on, the keyboard is in ten-key mode. Press NumLk to cancel.
Only capital letters can be input.	<ul style="list-style-type: none"> ● When the indicator  is on, the keyboard is in Caps Lock mode. Press Caps Lock to cancel.
Cannot enter special characters (ß, à, ç, etc.) and symbols.	<ul style="list-style-type: none"> ● Use the character map. Click [start] - [All Programs] - [Accessories] - [System Tools] - [Character Map].
Cannot use the keyboard in the Tablet mode.	<ul style="list-style-type: none"> ● <Only for model with Windows XP Professional> Use the software keyboard. (→ page 11) ● <Only for model with Windows XP Tablet PC Edition> Use the Tablet PC Input Panel. (Refer to the Windows Help.)







■ Display Rotation

The display angle does not change automatically when switching Laptop mode and Tablet mode.	<ul style="list-style-type: none"> ● Set the default angle correctly for each mode. (→ page 15) ● Do not switch the mode until the Fast User Switching is completed.
Cannot rotate the display.	<ul style="list-style-type: none"> ● Close all of the applications. ● You cannot rotate the display to 90° and 270° in the Tablet mode if you uninstalled Wireless Switch Utility or Intel® PROSet/Wireless Software. To reinstall, click [start] - [Run] and input [c:\util\wswitch\Setup.exe] (Wireless Switch Utility) / [c:\util\drivers\wlan\XP\Apps\x32\install.bat] (Intel® PROSet/Wireless Software), and click [OK]. Then restart the computer.
The operations of touch pad and touchscreen (only for model with touchscreen) do not match the rotation angle.	<ul style="list-style-type: none"> ● The operations do not match immediately after you start Windows. ● Close the applications and press the Rotation button until the operations match the rotation angle. The operations do not match in some applications or when you change the screen settings in [Display Properties] or Intel(R) GMA Driver for Mobile with the display rotated.

■ Network

Cannot connect to a network.	<ul style="list-style-type: none"> ● Set [LAN], or [LAN] and [Modem] to [Enabled] in the [Advanced] menu of the Setup Utility (→ page 89).
Cannot check the computer's MAC address.	<ul style="list-style-type: none"> ● Follow the steps below. <ol style="list-style-type: none"> ① Click [start] - [All Programs] - [Accessories] - [Command Prompt]. ② Input [ipconfig/all], and press Enter. ③ Write down the 12-digit string of alphanumeric displayed in the "Physical Address" line of the LAN or the wireless LAN (only for model with wireless LAN). ④ Input [exit], and press Enter.

■ Wireless Communication (only for model with wireless LAN/Bluetooth/wireless WAN)

Cannot connect to a network.	<ul style="list-style-type: none"> ● Slide the wireless switch to turn on the wireless devices. ● Set the devices ([Wireless LAN] / [Bluetooth] / [Wireless WAN]) to [Enabled] in the [Advanced] menu of the Setup Utility (→ page 90). ● Disable the Wireless Connection Disable Utility. ● Restart the computer. ● You cannot turn on wireless LAN if you uninstalled Display Rotation Tool. To reinstall it, click [start] - [Run] and input [c:\util\disprot\Setup.exe], and click [OK].
Access point is not detected.	<ul style="list-style-type: none"> ● Confirm that  /  /  is displayed on the notification area. ● If  /  /  is not displayed on the notification area, turn on the wireless communication (→ page 73).

■ Connecting Peripherals

An error occurs while installing the driver.	<ul style="list-style-type: none"> ● When you install a driver of card or peripheral device, make sure that the driver is compatible with the operating system. If it is not compatible, malfunction may occur. For information about the driver, contact the manufacturer of the peripheral device.
--	---

■ Connecting Peripherals

<p>A peripheral device does not work.</p>	<ul style="list-style-type: none"> ● Install the driver. ● Contact the manufacturer of the device. ● When operation resumes from standby or hibernation, devices such as a mouse, modem and cards may not function properly. In this case, restart the computer or reinitialize the device. ● When  is displayed in the Device Manager, remove and insert the device. If the problem persists, restart the computer. ● When you set [USB Port] to [Disabled] in the [Advanced] menu of the Setup Utility (→ page 90), USB ports of port replicator are also disabled. ● The computer may not recognize the connection/removal of some devices, or may not operate normally with some devices. <ol style="list-style-type: none"> ① Click [start] - [Control Panel] - [Performance and Maintenance] - [System] - [Hardware] - [Device Manager]. ② Select the device and remove the check mark for [Allow the computer to turn off this device to save power.] in [Power Management]. (This item may be unavailable for some types of devices.) ● In the case that a USB device does not work, remove the USB device and connect it again or connect the USB device to another port.
<p>The connected mouse does not work.</p>	<ul style="list-style-type: none"> ● Check the mouse connection. ● Install the driver compatible with the connected mouse. If the mouse does not work even after installing the driver, set [Touch Pad] to [Disabled] in the [Main] menu of the Setup Utility (→ page 87).
<p>USB floppy disk drive does not work as a boot drive.</p>	<ul style="list-style-type: none"> ● You can use only the Panasonic CF-VFDU03U USB floppy disk drive (optional). ● Connect the floppy disk drive directly to a USB port of the computer. Do not connect it via a USB hub or USB connector of the port replicator or the car mounter. If you have connected to a USB port on the computer, try connecting it to one of the other USB ports. ● Set [USB Port] and [Legacy USB Support] to [Enabled] in the [Advanced] menu of the Setup Utility (→ page 90). ● Set [Boot Option #1] to [USB Floppy Disk] in the [Boot] menu of the Setup Utility (→ page 91). ● Turn off the computer and connect the USB floppy disk drive, and then restart the computer.
<p>The RAM module is not recognized.</p>	<ul style="list-style-type: none"> ● Insert the RAM module correctly. ● Use the compatible RAM module (→ page 39). ● Check the [Information] menu in the Setup Utility (→ page 86). If the RAM module is not recognized, turn off the computer and reinsert the RAM module.

■ Connecting Peripherals

You do not know the address map for IRQ, I/O port address, etc.	<ul style="list-style-type: none">● To check the current address map, click [start] - [Control Panel] - [Performance and Maintenance] - [System] - [Hardware] - [Device Manager] - [View] - [Resources by type].
The device connected to the serial port does not work.	<ul style="list-style-type: none">● Check the connection.● The device driver may not work. Refer to the instruction manual of the device.● Do not connect 2 mouse devices simultaneously.● Set [Touch Pad] to [Disabled] in the [Main] menu of the Setup Utility (→ page 87).● Set [Serial Port A] or [Serial Port B] to [Auto] in the submenu of [Serial Port Settings] in the [Advanced] menu of the Setup Utility (→ page 89).● The I/O and IRQ you can use vary depending on the device. If the setting does not work, try other settings in the Setup Utility.
The Serial Port B of the port replicator or the car mounter does not work.	<ul style="list-style-type: none">● Set [Serial Port B] to [Auto] in the submenu of [Serial Port Settings] in the [Advanced] menu of the Setup Utility (→ page 89).
Cannot print.	<ul style="list-style-type: none">● Check the printer connection.● Turn on the printer.● The printer is not online.● No paper is in the printer tray or there is a paper jam.● Turn on the printer and connect it to the computer, and then restart the computer.● Check the network connection if the printer is connected via network.

■ Connecting Peripherals

<p>LAN transmission speed slows down noticeably. Poor performance during data transmission via a PC Card (e.g., distorted video image when writing to a DV camera using an IEEE1394 PC Card). <Only for model with wireless LAN> Wireless LAN connection is cut.</p>	<ul style="list-style-type: none"> ● These problems may occur due to performance loss that results from the CPU power-saving function. Log on to Windows as an administrator and follow the steps below. <ol style="list-style-type: none"> ① Click [start] - [Run] and input [c:\util\cpupower\setup.exe], and click [OK]. Follow the on-screen instructions. ② Click [start] - [All Programs] - [Panasonic] - [CPU Idle Setting]. ③ Click [Performance] and click [OK], then click [Yes]. The computer will restart. <ul style="list-style-type: none"> ● If the problem persists, click [start] - [Control Panel] - [Performance and Maintenance] - [Power Options] - [Power Schemes], select [Always On] in [Power Schemes], and click [OK]. ● The above remedy is effective for performance loss resulting from the CPU power saving function, but not for other causes (e.g., noise generated by high CPU load such as video playback). ● The above remedy slightly reduces the battery operation time. Normally it is recommended to select [Battery (Windows XP Standard)] in [CPU Idle Setting] and to select [Portable/Laptop] in [Power Schemes].
---	---

■ Touch Pad / Touchscreen (only for model with touchscreen)/Dual Touch (only for model with dual touch)

<p>The cursor does not work.</p>	<ul style="list-style-type: none"> ● Connect the external mouse correctly. ● Restart the computer using the keyboard. (Press F12, U, and R to select [Restart].) ● If the computer does not respond to keyboard commands, read “No response.” (→ page 117).
<p>Cannot input using the touch pad.</p>	<ul style="list-style-type: none"> ● Set [Touch Pad] to [Enabled] in the [Main] menu of the Setup Utility (→ page 87). ● The touch pad may be disabled by some mouse drivers. Check your mouse’s operating instructions.
<p>Cannot point the correct position using the included stylus/digitizer pen.</p>	<ul style="list-style-type: none"> ● <Only for model with touchscreen> Perform the touchscreen calibration (→ page 7). ● <Only for model with dual touch> Perform the dual touch calibration (→ page 9).

■ PC Card / ExpressCard (only for model with ExpressCard slot)

A card does not work.	<ul style="list-style-type: none">● Insert the card correctly.● The card does not conform to the card standard.● Restart the computer after installing a driver (of card or other device).● Set [PC Card Slot] and [ExpressCard Slot] to [Enabled] in the [Advanced] menu of the Setup Utility (→ page 90).● The port settings are not correct.● Read the instruction manual of the card or contact the manufacturer of the card.● Remove the card and insert it again (→ page 32).● The driver is not compatible with the operating system.
-----------------------	---

■ SD Memory Card

Cannot use an SD Memory Card.	<ul style="list-style-type: none">● Set [SD Slot] to [Enabled] in the [Advanced] menu of the Setup Utility (→ page 90).
-------------------------------	---

■ Smart Card (only for model with Smart Card slot)

Cannot use a Smart Card.	<ul style="list-style-type: none">● Insert the Smart Card correctly.● Set [Smart Card] to [Enabled] in the [Advanced] menu of the Setup Utility (→ page 90).● To use a Smart Card, you need a specified software and driver.
--------------------------	--

■ Fingerprint Reader (only for model with Fingerprint Reader)

<p>The sensor does not enroll or authenticate my fingerprint.</p>	<ul style="list-style-type: none"> ● Slide your finger correctly. For further information about enrollment and authentication, refer to “How to Use the Fingerprint Reader” (→ page 47) and [Fingerprint Tutorial]. <ul style="list-style-type: none"> • Click [start] - [All Programs] - [Protector Suite QL] - [Fingerprint Tutorial]. ● The sensor enrolls or authenticates no fingerprint, or performs authentication poorly, despite the correct way of finger sliding when your finger is in any of the conditions stated below: <ul style="list-style-type: none"> • Rough skin, or injured finger (with a cut or a skin inflammation) • Extremely dry • Soiled with mud or oil • Fingerprint has been worn and has faded • Wet with water or sweat <p><You can improve enrolling and authentication sensitivity by taking the following steps when any of the conditions described above exists></p> <ul style="list-style-type: none"> • Wash your hands or wipe them dry. • Use a different finger for registration or authentication. • Treat your finger with a hand cream when it is rough skin or dry. ● Clean the fingerprint sensor. For further information, refer to “Handling & Maintenance” (→ page 54). ● The fingerprint sensor may be malfunctioning when it continues to perform poorly after the steps described above have been performed. Contact Panasonic Technical Support.
<p>Sensor does not work.</p>	<ul style="list-style-type: none"> ● Exported passport can help you if you need to replace the sensor. <ul style="list-style-type: none"> • Log on to Windows as an Administrator. You can always access the computer by using your Windows log on password. In convenient mode, any user can access the computer by using your Windows log on password. • To access [File Safe] [File Safe] can be always accessed by using the [File Safe] backup password. • Other functions Replace/Repair the sensor, then follow the instructions in section “Replacing sensor.” (→ page 115). <p>Some limited functions (e.g. deleting passport) is available without a functional sensor. In case of deleted operation, it is necessary to cancel the fingerprint verification operation to get to the password dialog.</p>

■ Fingerprint Reader (only for model with Fingerprint Reader)

<p>User cannot use enrolled finger. (e.g. injury)</p>	<ul style="list-style-type: none"> ● It is strongly recommended to enroll at least two fingers to avoid this problem. If you enrolled multiple fingers, simply use other finger. If you only enrolled one finger that can be used, we recommend to use the [Enroll or Edit Fingerprints] wizard and enroll additional fingerprints. <p>If none of your enrolled fingers can be used, follow this procedure:</p> <ol style="list-style-type: none"> ① Log on to Windows as an Administrator. You can always access the computer by using your Windows log on password. In convenient mode, any user can access the computer by using your Windows log on password. ② Update the enrolled fingerprints. To be able to fully use Protector Suite QL, you need to have usable enrolled fingerprints. Enter the [Enroll or Edit Fingerprints] wizard. <ul style="list-style-type: none"> • If you do not use [Advanced Security], you can still enter using the Windows password. • If you use [Advanced Security] with backup password, you can enter using the backup password. • If you use [Advanced Security] without backup password, there is no other way to add a different fingerprint. In this case we recommend either to wait until your finger is usable again (e.g. the injury heals), or to delete the passport (Use [Delete] wizard) and then reenroll new fingerprints. Please note that in the latter case all your stored secret data (passwords, [File Safe] encryption keys) will be lost. To perform the delete operation it is necessary to cancel the fingerprint verification operation to get to the password dialog, then enter your Windows log on password. • To access [File Safe] If you did not perform the procedure in step ② or it did not work, you can still access [File Safe] by using the [File Safe] backup password.
<p>TPM failure.</p>	<ul style="list-style-type: none"> ● If you use [Advanced Security] with TPM (Trusted Platform Module) and TPM is broken, erased or disabled, the [Advanced Security] will not work anymore. If you do not use the [Advanced Security] backup password, refer to "Starting Over". Otherwise, if you use [Advanced Security] backup password, you can follow these steps: <ol style="list-style-type: none"> ① Enter the [Enroll or Edit Fingerprints] wizard using the backup password. ② Disable [Advanced Security] and finish. ③ After the TPM is repaired and enabled (or if you only erased its contents) you can enter the [Enroll or Edit Fingerprints] wizard again using your finger and enable the [Advanced Security] with TPM again.

■ Fingerprint Reader (only for model with Fingerprint Reader)

<p>Replacing sensor.</p>	<ul style="list-style-type: none"> ● If you need to replace a non-functioning fingerprint reader, follow this procedure. Enrollment to the hard disk: If enrollment to hard disk is used, "Protector Suite QL" has not stored any data on the device and therefore has no problem to continue after you replaced the sensor. However, in case you use the Power-on security (Preboot Authentication), you may need to use the [Enroll or Edit Fingerprints] wizard to update the related data. Enrollment to the device: If the fingerprint has been enrolled to the device, a new passport will be required. Follow the procedure in the section "Starting Over".
<p>Lost [Advanced Security] backup password.</p>	<ul style="list-style-type: none"> ● To change the [Advanced Security] backup password, go to the [Enroll or Edit Fingerprints] wizard and swipe your finger and go through the Fingerprint enrollment. On the Advanced Security page you can change the backup password.
<p>Protector Suite QL reinstallation.</p>	<ul style="list-style-type: none"> ● During Protector Suite QL uninstallation, you can select whether to delete the Protector Suite Data - including passports. ● If you want to reinstall the product, select button to leave the Protector Suite QL data on the computer. After the new installation, you will be able to use your data again. ● If the Protector Suite QL was uninstalled including the passports, then in case of enrollment to device the fingerprints will still be stored in the device and the user can use them reenrollment.
<p>Lost [File Safe] backup password.</p>	<ul style="list-style-type: none"> ● It is necessary to change the backup password for [File Safe], refer to the software's online manual (→ page 48).
<p>Accessing [File Safe] after Protector Suite QL uninstallation.</p>	<ul style="list-style-type: none"> ● [File Safe] data can be accessed only using Protector Suite QL. If you accidentally uninstalled Protector Suite QL, you have to reinstall it. If passport data was not removed during uninstallation, everything will work automatically including [File Safe]. If the passport data was removed during uninstallation the [File Safe] will recognize that the installation was changed and will offer to use the backup password, instead.
<p>Accessing [File Safe] after computer crash.</p>	<ul style="list-style-type: none"> ● If you have an exported passport, import it now so you can access [File Safe] directly using fingerprints. Otherwise you can access [File Safe] using the [File Safe] backup password: [File Safe] will recognize that the installation was changed and will offer to use the backup password, instead.

■ Fingerprint Reader (only for model with Fingerprint Reader)

<p>Removing data from the reader.</p>	<ul style="list-style-type: none"> ● When enrollment to the device is used, passport data is stored to the device. To remove it, go to the [Delete] passport wizard and delete existing passports, and then use the [Fingerprint Storage Inspector] to remove remaining fingerprints (e.g. left over from previous installations). ● In convenient mode, the [Fingerprint Storage Inspector] does not allow deleting the last fingerprint for an existing passport and only user's own fingerprints can be deleted. Therefore it is necessary to delete passports first.
<p><Only for model with Tablet PC Edition> Tablet PC Input Panel is hidden under "Please wipe your finger" message.</p>	<ul style="list-style-type: none"> ● Move Tablet PC Input Panel according to the following order. <ol style="list-style-type: none"> ① Log on to Windows. ② Click [start] - [All Programs] - [Protector Suite QL] - [Control Center] - [Settings] - [System Settings]. ③ Remove a check mark for [Enable logon support], and click [OK]. ④ Log off Windows. ⑤ Move Tablet PC Input Panel to the bottom right or bottom left. ⑥ Log on to Windows. ⑦ Click [start] - [All Programs] - [Protector Suite QL] - [Control Center] - [Settings] - [System Settings]. ⑧ Add a check mark for [Enable logon support], and click [OK].

■ Fast User Switching Function

<p>Some applications do not work properly.</p>	<ul style="list-style-type: none"> ● When switching to a different user with the Fast User Switching function, the following problems may occur. <ul style="list-style-type: none"> • Some applications may not work properly. • Key combination with Fn may not work. • The display settings may not be possible. • A serial mouse may not work. • <Only for model with wireless LAN> Wireless LAN cannot be used. • <Only for model with Bluetooth> Bluetooth cannot be used. <p>In these cases, log off all users without using Fast User Switching function and perform the operation once more. If the problem persists, restart the computer.</p>
--	--

■ Others

No response.	<ul style="list-style-type: none">● Press Ctrl+Shift+Esc to open Task Manager and close the software application.● An input screen (e.g., password input screen at startup) may be hidden behind another window. Use Alt+Tab to check.● Shut down by sliding and holding the power switch for four seconds or longer, and turn on the computer and open the application again. If it no longer works normally, delete and reinstall it. Click [start] - [Control Panel] - [Add or Remove Programs].
--------------	---

Checking the Computer's Usage Status

You can check the computer's usage status in the PC Information Viewer. You may need this information when calling Panasonic Technical Support for advice.

NOTE

- This computer periodically records the management information of the hard disk etc. The maximum data volume for each record is 1024 bytes. The information is only used for estimating the cause when the hard disk goes down by any possibility. They are never sent to outside via network nor used for any other purpose except for the purpose described the above.
To disable the function, add the check mark for [Disable the automatic save function for management information history] in [Hard Disk Status] of PC Information Viewer, and click [OK].
- If you have not logged on with the administrator authority, some information will be displayed as [Not Found].
- As long as it is activated, the PC Information Viewer will appear in front of all other screens.
- Depending on your network environment, it may take 1 minute to start the PC Information Viewer.

1 Click [start] - [All Programs] - [Panasonic] - [PC Information Viewer] - [PC Information Viewer].

2 Select the item to display the detailed information.

■ To save the information as a text file

- ① Display the information you want to save.
 - ② Click [Save].
 - ③ Select the file save range option and click [OK].
 - ④ Select the folder to save the information, input the file name, and click [Save].
- If automatic saving of the management information record has not been disabled, the records already recorded are also saved.

■ To save a copy of the screen as an image file

- ① Display the screen you want to save.
- ② Press **Ctrl+Alt+F7**.
- ③ When the screen copy message appears, click [OK].
The screen image is saved in [My Documents] folder.
 - Alternatively you can save a copy of the screen in the following procedure.
Click [start] - [All Programs] - [Panasonic] - [PC Information Viewer] - [Screen Copy].

NOTE

- The image is a bitmap file in 256 colors.
- When using the extended desktop (→ [page 44](#)), a copy of the primary device screen is saved.
- The default key combination to copy is **Ctrl+Alt+F7**. You can change it in the following procedure.
 - ① Log on to Windows as an administrator, and click [start] - [All Programs] - [Panasonic] - [PC Information Viewer].
 - ② Right-click [Screen Copy] - [Properties] and click [Shortcut].
 - ③ Click [Shortcut key] and press the key(s) you want to use for the shortcut.
 - ④ Click [OK].

- Copyright

This manual is copyrighted by Panasonic Corporation with all rights reserved. No part of this manual may be reproduced in any form without the prior written permission of Panasonic Corporation. No patent liability is assumed with respect to the use of the information contained herein.

© Panasonic Corporation 2008

- Disclaimer

Computer specifications and manuals are subject to change without notice. Panasonic Corporation assumes no liability for damage incurred directly or indirectly from errors, omissions or discrepancies between the computer and the manuals.

- Trademarks

- Microsoft, Windows and the Windows logo are registered trademarks of Microsoft Corporation of the United States and/or other countries.
- Intel, Core, Centrino and PROSet are either registered trademarks or trademarks of Intel Corporation.

- SDHC Logo is a trademark.



- Adobe, the Adobe logo and Adobe Reader are either registered trademarks or trademarks of Adobe Systems Incorporated in the United States and/or other countries.
- Bluetooth™ is a trademark owned by Bluetooth SIG, Inc., U.S.A. and licensed to Panasonic Corporation.
- PS/2® is a registered trademark of International Business Machines Corporation.
- Names of products, brands, etc., appearing in this manual are trademarks or registered trademarks of their respective own companies.